

# chirurgisches Wahntmaterial

 **RESORBA**<sup>®</sup>  
REPAIR AND REGENERATE



In der Natur müssen verletzte oder zerstörte Gewebeschichten rasch geschlossen werden, um die Integrität und Funktion des Organismus aufrecht zu erhalten. Diese Vorgehensweise hat der Mensch von der Natur übernommen.

Ein Ziel der modernen Wundversorgung ist dabei in erster Linie der Erhalt noch intakter Gewebe und die Unterstützung der geschädigten Bereiche. Unsere Nahtmaterialien auf der Basis bioverträglicher Rohstoffe ermöglichen den gezielten Einsatz bei jeder Art der Wundversorgung und garantieren bestmögliche Gewebeverträglichkeit.

Chirurgisches Nahtmaterial dient als typisches Medizinprodukt zur Reparatur von Geweben. Noch immer werden die meisten Wundverschlüsse mit Nähten ausgeführt. Dabei ist die mechanische Eigenschaft der eingesetzten Materialien von größter Bedeutung, um die verlorene Festigkeit zeitweilig zu ersetzen.

Absorbierbare Werkstoffe, wie z.B. PGA Resorba®, unterstützen dabei die natürlichen Reparaturvorgänge, bis Form und Funktion wieder hergestellt sind. Anschließend werden diese im Organismus abgebaut.

Nicht-absorbierbare Fadenmaterialien (z.B. Mopylen®) garantieren dauerhafte Unterstützung und beste Bioverträglichkeit, wie sie insbesondere bei Langzeitimplantaten gefordert wird.

*In nature, tissue layers that have been damaged or destroyed must be closed promptly to maintain the integrity and normal functioning of the body. Man has adopted this process from nature.*

*One primary aim of modern wound care is to preserve tissues that are still intact, and to support areas that have been damaged. Our suture products, created from biocompatible starting materials, can be employed specifically in any form of wound care and guarantee the best possible tissue tolerance.*

*Surgical suture materials are a typical medical product used for repairing tissues. Sutures are still employed for the closure of most wounds. The mechanical properties of suture materials are therefore of great importance if they are to make good the temporary loss of tissue integrity and strength.*

*Absorbable suture materials such as PGA Resorba® underpin the natural processes of repair until form and function have been restored. They are then broken down within the body.*

*Non-absorbable suture materials such as Mopylen® guarantee lasting support and optimal biocompatibility, essential requirements for long-term implants.*

# Inhaltsübersicht

## Allgemeine Übersicht

PEEL-eco-Pack	3
Micro-Pack	4
Multi-L-Pack / Organisationshilfen	5
Reso-Clip / Fadentabelle	6
Symbole	7-8
Tips / Die Nadel	9
Nadel-Daten	10-12
Nadel-Programm	13-16

## Seite

## Produktübersicht

GLYCOLON®
PGA <i>resoquick</i> ™
PGA RESORBA®
CAPROLON®
MOPYLEN®
RESOPREN®
POLYESTER
SUPOLENE
NYLON
RESOLON®
SUPRAMID
SEIDE
STAHL DRAHT
SPEZIALKOMBINATIONEN
FEDERÖHRNADELN
PREISLISTE

# Index

## General Information

PEEL-eco-Pack	3
Micro-Pack	4
Multi-L-Pack / Organizational support	5
Reso-Clip / Suture table	6
Symbols	7-8
Suggestions / The Needle	9
Needle data	10-12
Needle range	13-16

## Page

## Product Range

GLYCOLON®
PGA <i>resoquick</i> ™
PGA RESORBA®
CAPROLON®
MOPYLEN®
RESOPREN®
POLYESTER
SUPOLENE
NYLON
RESOLON®
SUPRAMID
SILK
STEEL WIRE
SPECIALIST PRODUCTS
SPRING-EYE-NEEDLES
PRICE LIST

# Peel-eco-pack

Eine Kombination aus peel-fähiger Umverpackung und multifunktionaler Innenverpackung.  
*A combination of peelable outer sachet and multifunctional inner sachet.*

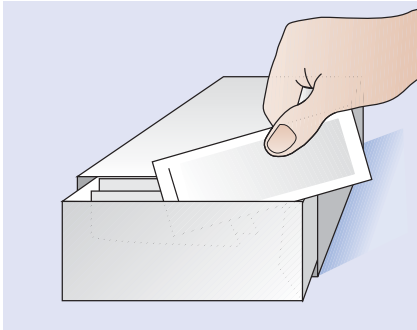

1. Entnahme der Peel-Packung aus dem Vorratskarton.

*Remove the peel pack from the storage box.*

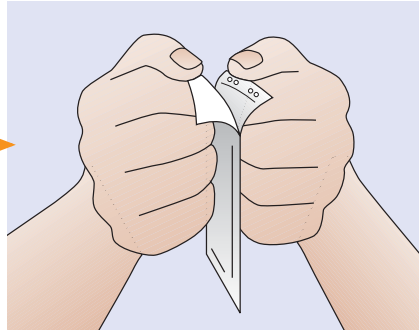

2. Der Springer greift die beiden Aufziehlaschen am oberen Ende der Packung und öffnet diese durch gleichmäßiges Peelen.

*The circulating nurse grasps the two tabs at the upper end of the pack and opens them by peeling them apart evenly.*

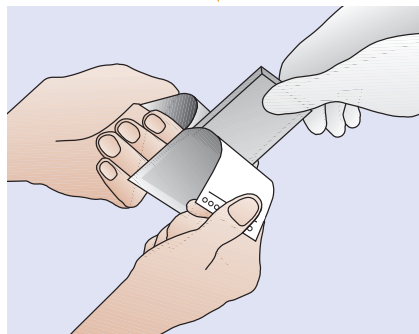

3. Steriler Inhalt wird kontaminationsfrei angereicht.

*The sterile contents are passed to the surgeon without contaminating them.*

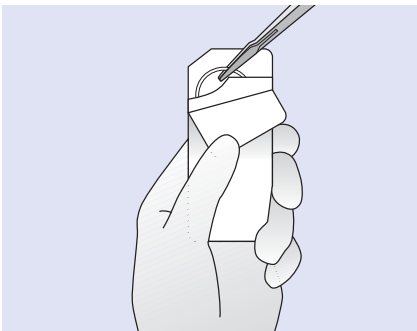

## **Einzelpack/Nadel-Faden-Kombination**

Beim Umklappen der perforierten Lasche wird die Nadel freigelegt. Diese wird anschließend mit dem Nadelhalter entnommen.

## **Individual pack/needle-thread combination**

*The needle is exposed by folding back the perforated tab and then withdrawn with the needle holder*

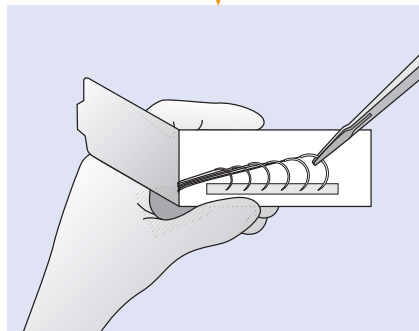

## **Multipack**

Durch seitliches Aufklappen der Papierabdeckung werden die Nadeln freigelegt und anschließend einzeln (nacheinander) mittels Nadelhalter entnommen.

## **Multi pack**

*The needles are exposed by folding the paper cover to the side. They are then withdrawn individually (one after another) with the needle holder.*

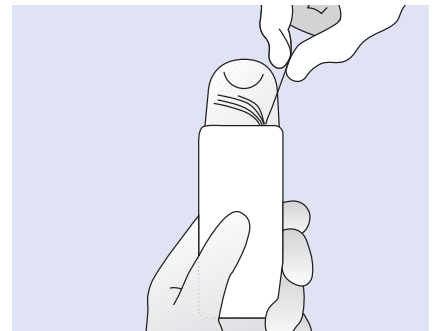

## **Kurzfäden**

Nach Aufklappen der oberen Lasche können die Einzelfäden in beliebiger Reihenfolge entnommen werden.

## **Pre-cut sutures**

*After the upper tab has been folded back the individual threads can be withdrawn in any order*

# Micro-Pack

## Packungen mit Schaumstoff-Trägern für die Mikro- und Augenchirurgie Packs with foam carriers for microsurgery and ophthalmic surgery

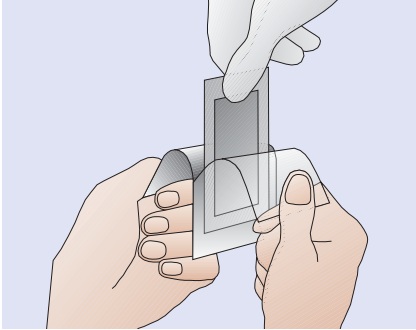

1. Aufpeelen des unsterilen Außenbeutels und kontaminationsfreies Anreichen des sterilen Innenbeutels.

*Peel open the unsterile outer sachet and grasp the sterile inner sachet without contaminating it.*

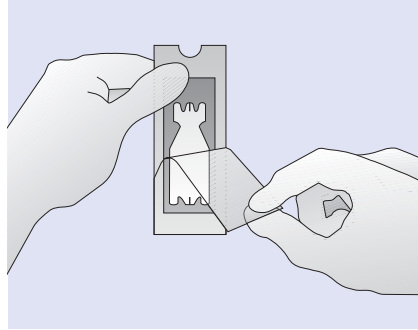

2. Aufpeelen des sterilen Innenbeutels.

*Peel open the sterile inner sachet.*

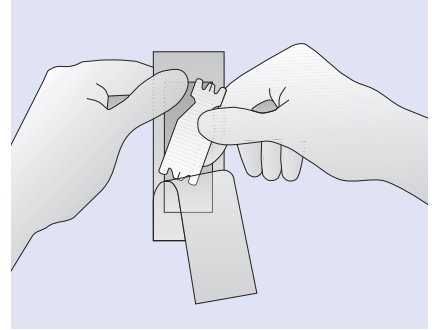

3. Vorsichtige Entnahme des sterilen Fadenträgers aus dem Blisterbeutel.

*Carefully remove the sterile suture carrier from the blister.*

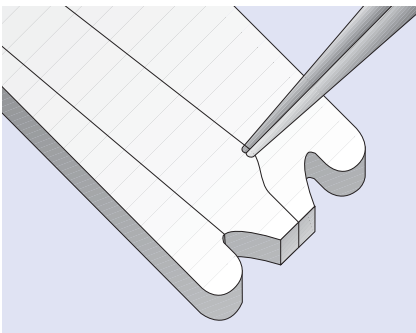

4. Vor Nadelentnahme fixierten Faden mit Pinzette vom Träger lösen.

*Before removing the needle, separate the thread from the carrier with forceps.*

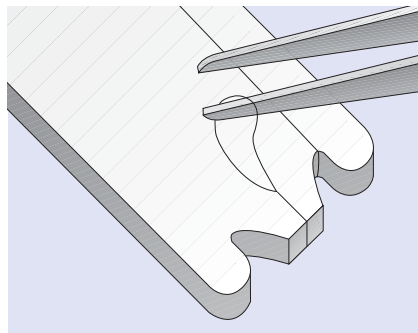

5. Bei doppelt armiertem Faden, erst Fadenschleife lösen bzw. durchtrennen, dann Faden mit Pinzette vom Träger lösen.

*In the case of double-armed threads, firstly separate/cut the needle loop and then separate the thread from the carrier with forceps.*

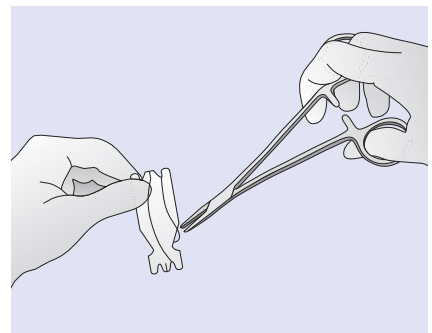

6. Nadel mit Nadelhalter fassen und durch leichtes Drehen vom Träger nehmen.

*Grasp the needle with the needle holder and remove it from the carrier by gently rotating it.*

7. Während der Operation kann die Nadel im sterilen Träger „geparkt“ werden. Nach der Operation dient der Träger zur Aufnahme und Kontrolle der eingesetzten Nadeln.

*During the operation the needle can be „parked“ in the sterile carrier. After the operation the carrier serves as a recipient for checking the number of needles used.*

## Multi-L-Pack

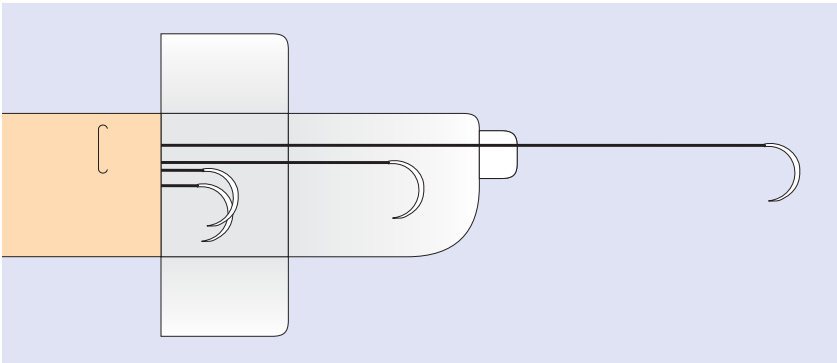

### Multi-L-Pack

Spezielle Kombinationen werden zur Vermeidung des Memory-Effekts im Multi-L-Pack angeboten. Dies ermöglicht die problemlose und schnelle Entnahme.

### Multi-L-Pack

*Special combinations are available for preventing the memory effect in the Multi-L-Pack. This ensures rapid, problem-free removal.*

## Organisationshilfen / Organizational support

### 1. Set-Verpackung

Individuelle Zusammenstellung verschiedener Nahtmaterialien in einem Set nach Ihren indikationsspezifischen Vorgaben über Material, Menge und Reihenfolge.

- Mindestabnahme: 72 Stück
- Fertigung ohne Aufpreis
- Beschriftung mit allen relevanten Angaben (Indikation, Inhalt, ...)
- Eine LOT-Nr. für gesamtes Set

### 1. Set packs

*Individually tailored combinations of various suture materials in accordance with your indicationspecific instructions regarding material, amount, and sequence.*

- *Minimum purchase: 72 items*
- *Prepared at no additional charge*
- *Lettering with all necessary data (indication, content, ...)*
- *Only one LOT-no. for the whole set*

### 2. Sonderanfertigung

Sollten Sie eine Kombination benötigen, die Sie nicht in unserem Katalog finden, fertigen wir diese ohne Aufpreis nach Ihren individuellen Anforderungen, sofern dies technisch machbar ist. Bitte beachten Sie die längere Lieferzeit sowie eine Mindestabnahme von 15 Dutzend (Umtausch ausgeschlossen).

### 2. Special orders

*Should you require a combination that does not feature in our catalogue, we will prepare it for you according to individually needs at no additional price provided that it is technically possible to do so. Please note that delivery times are longer than with standard orders and that there is no exchange possible.*

### 3. Kombi-Box

Das Aufbewahrungsmagazin für Standard-Nahtmaterialpackungen zur übersichtlichen Organisation im OP (horizontal/vertikal zusammensteckbar).

### 3. Combination Box

*The container for storing standard packs of suture materials provides easy access to suture materials in the operating theatre (horizontally and vertically attachable).*

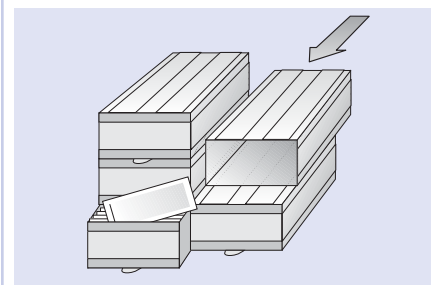
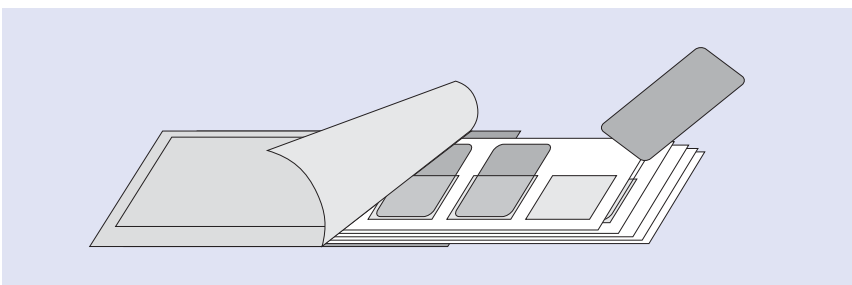

# Reso-Clip

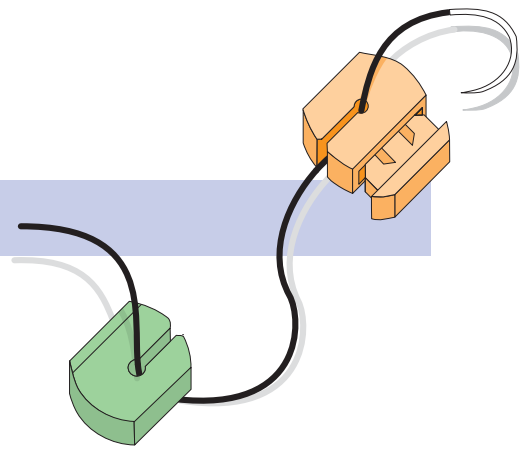

**Intrakutan-Naht mit Reso-Clip  
für ein optimales kosmetisches Ergebnis schnittförmiger Wunden**

*Intracutaneous Suture with Reso-Clip  
for an optimal cosmetic result of incised wounds*

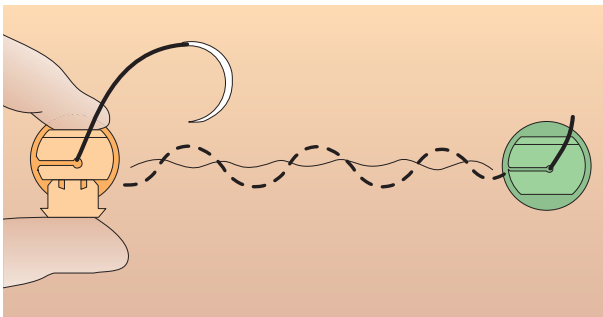
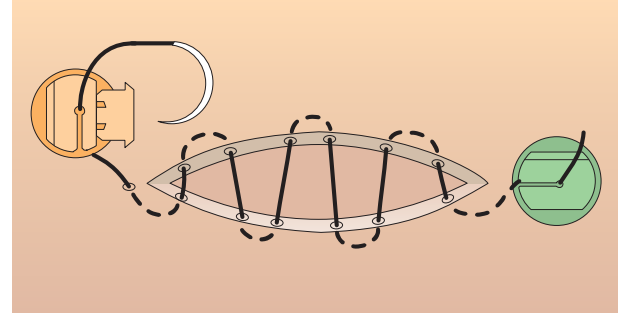
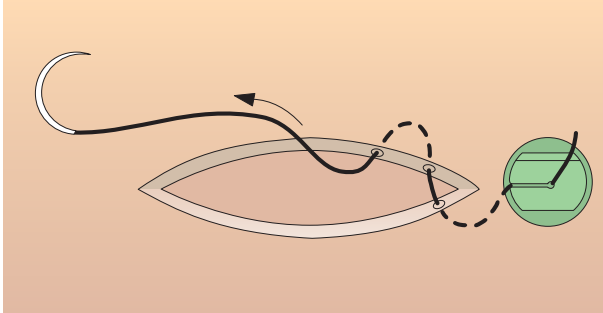

- Durchstechen der Haut an nur zwei Punkten
- Nahtmaterial wird nicht geknotet
- Fixierung der Fadenenden durch Kunststoff-Clips
- Nach Wundheilung wird ein Clip abgeschnitten
- Durch Ziehen am zweiten Clip wird das Fadenmaterial leicht aus der Wunde entfernt
- *Pierce the skin at two sites only*
- *Suture knots are not required*
- *Secure the suture ends with plastic clips*
- *After the wound has healed cut off one of the clips*
- *The suture can be removed from the wound easily by pulling out of the second clip*











## Fadentabelle / Suture table

Plz.Eur	Durchmesser- spanne in mm Diameter range in mm	PGA RESORBA®	PGA resosquick™	MOPYLEN®	RESOPREN®	POLYESTER	SUPOLENE	NYLON monofil RESOLON®	SUPRAMID	SEIDE SILK	DRAHT polyfil STEEL multifilament	DRAHT monofil STEEL monofilament	Synth. monofil Durchmesser- spanne in mm Synth. monofilament Diameter in mm	GLYCOLON®	CAPROLON®
0.1 EP	0,010-0,019	-	-	-	-	-	-	11-0	-	-	-	-	-	-	-
0.2 EP	0,020-0,029	10-0	-	10-0	-	-	-	10-0	-	10-0	-	-	-	-	-
0.3 EP	0,030-0,039	9-0	-	9-0	-	-	-	9-0	-	9-0	-	-	-	-	-
0.4 EP	0,040-0,049	8-0	-	8-0	8-0	-	-	8-0	-	8-0	-	-	-	-	-
0.5 EP	0,050-0,069	7-0	-	7-0	7-0	7-0	-	7-0	7-0	7-0	-	-	0,050-0,094	-	7-0
0.7 EP	0,070-0,099	6-0	6-0	6-0	6-0	6-0	6-0	6-0	6-0	6-0	6-0	6-0	0,095-0,149	6-0	6-0
1 EP	0,100-0,149	5-0	5-0	5-0	5-0	5-0	5-0	5-0	5-0	5-0	5-0	5-0	0,150-0,199	5-0	5-0
1.5 EP	0,150-0,199	4-0	4-0	4-0	4-0	4-0	4-0	4-0	4-0	4-0	4-0	4-0	0,200-0,249	4-0	4-0
2 EP	0,200-0,249	3-0	3-0	3-0	3-0	3-0	3-0	3-0	3-0	3-0	3-0	3-0	0,250-0,339	3-0	3-0
2.5 EP	0,250-0,299	-	2-0	-	-	-	-	2-0	-	-	-	-	-	-	-
3 EP	0,300-0,349	2-0	2-0	2-0	2-0	2-0	2-0	2-0	2-0	2-0	2-0	2-0	0,340-0,399	2-0	2-0
3.5 EP	0,350-0,399	0	0	0	0	0	0	0	0	0	0	0	0,400-0,499	0	0
4 EP	0,400-0,499	1	1	1	1	1	1	1	1	1	1	1	0,500-0,570	1	1
5 EP	0,500-0,599	2	2	2	-	2	2	2	2	2	2	2	0,571-0,610	-	2
6 EP	0,600-0,699	3+4	-	-	-	3+4	3+4	-	3+4	3+4	3+4	3+4	-	-	-
7 EP	0,700-0,799	5	-	-	-	5	5	-	5	5	-	5	-	-	-
8 EP	0,800-0,899	-	-	-	-	6	6	-	6	6	-	6	-	-	-
9 EP	0,900-0,999	-	-	-	-	7	7	-	7	-	-	7	-	-	-

## Wußten Sie schon? / Do you know?

### Kleine Symbollehre für Medizinprodukte







### A short lesson in symbols used for medical products

	Bestellnummer	Reference number
	Chargenbezeichnung	Batch number
	Verwendbar bis Jahr - Monat	Use by year-month
	Gebrauchsanweisung beachten	Consult instructions for use
	Nicht zur Wiederverwendung	Do not reuse
	Nicht erneut sterilisieren	Do not resterilize
	Bei beschädigter Verpackung nicht verwenden	Do not use if package is damaged
	Sterilisation mit Ethylenoxid	Sterilised using ethylene oxide
	Obere Temperaturbegrenzung	Upper Limit of Temperature
	CE-Kennzeichnung und Kennnummer der benannten Stelle. Das Produkt entspricht den grundlegenden Anforderungen der Richtlinie des Rates über Medizinprodukte 93/42/EWG	CE mark and identification Number of the Notified Body. Product conforms to the essential requirements of the Medical Device Directive 93/42/EEC
	HIBC-Code	HIBC-Code

## Symbolerklärungen zur Chemischen Zusammensetzung synthetischer Nahtmaterials Explanation of symbols used for the chemical composition of synthetic sutures

<b>PGA-PCL</b>	GLYCOLON®	Poly(Glycolide-Co-Caprolactone)	<i>Poly(glycolide-co-caprolactone)</i>
<b>PGA</b>	PGA <i>resoquick</i> ™	Polyglykolsäure	<i>Polyglycolic acid</i>
<b>PGA</b>	PGA <i>RESORBA</i> ®	Polyglykolsäure	<i>Polyglycolic acid</i>
<b>P(LA/CL)</b>	CAPROLON®	Poly(Lactid-Caprolacton)	<i>Poly(lactide-caprolactone)</i>
<b>PP</b>	MOPYLEN®	Polypropylen	<i>Polypropylene</i>
<b>PVDF</b>	RESOPREN®	Polyvinylidendifluorid	<i>Polyvinylidene difluoride</i>
<b>PET</b>	POLYESTER	Polyester	<i>Polyester</i>
<b>PET</b>	SUPOLENE	Polyester	<i>Polyester</i>
<b>PA</b>	NYLON	Polyamid	<i>Polyamid</i>
<b>PA</b>	RESOLON®	Polyamid	<i>Polyamid</i>
<b>PA</b>	SUPRAMID	Polyamid	<i>Polyamid</i>

## Symbolerklärungen / Explanation of Symbols







	Abziehnadel <i>control release needle</i>		Schlingennaht <i>loop suture</i>
	Resoclip <i>Resoclip</i>		Ligatupack/-spule <i>ligature pack</i>
	Schlinge <i>loop</i>		Pledgets <i>pledgets</i>



## Neue Materialsymbole auf der Verpackung / *New symbols used on packaging*











### Resorbierbares Nahtmaterial

### *absorbable suture material*

	gefärbt / geflochten / beschichtet / resorbierbar	<i>dyed / braided / coated / absorbable</i>	PGA RESORBA®
	gefärbt / monofil / beschichtet / resorbierbar	<i>dyed / monofilament / coated / absorbable</i>	CAPROLON®
	gefärbt / monofil / resorbierbar	<i>dyed / monofilament / absorbable</i>	GLYCOLON®
	ungefärbt / geflochten / beschichtet / resorbierbar	<i>undyed / braided / coated / absorbable</i>	PGA RESORBA®, PGA resoquick™
	ungefärbt / monofil / beschichtet / resorbierbar	<i>undyed / monofilament / coated / absorbable</i>	CAPROLON®
	ungefärbt / monofil / resorbierbar	<i>undyed / monofilament / absorbable</i>	GLYCOLON®

### Nicht-resorbierbares Nahtmaterial

### *nonabsorbable suture material*

	gefärbt / geflochten / beschichtet / nicht-resorbierbar	<i>dyed / braided / coated / nonabsorbable</i>	SUPOLENE
	gefärbt / geflochten / nicht-resorbierbar	<i>dyed / braided / nonabsorbable</i>	POLYESTER, SEIDE SILK
	gefärbt / gezwirnt / beschichtet / nicht-resorbierbar	<i>dyed / twisted / coated / nonabsorbable</i>	SUPRAMID
	gefärbt / gezwirnt / nicht-resorbierbar	<i>dyed / twisted / nonabsorbable</i>	SEIDE SILK
	gefärbt / monofil / nicht-resorbierbar	<i>dyed / monofilament / nonabsorbable</i>	MOPYLEN®, RESOPREN®, NYLON, RESOLON®
	ungefärbt / geflochten / beschichtet / nicht-resorbierbar	<i>undyed / braided / coated / nonabsorbable</i>	SUPOLENE
	ungefärbt / geflochten / nicht-resorbierbar	<i>undyed / braided / nonabsorbable</i>	POLYESTER, SEIDE SILK
	ungefärbt / gezwirnt / beschichtet / nicht-resorbierbar	<i>undyed / twisted / coated / nonabsorbable</i>	SUPRAMID, STAHL DRAHT STAINLESS STEEL
	ungefärbt / gezwirnt / nicht-resorbierbar	<i>undyed / twisted / nonabsorbable</i>	STAHL DRAHT STAINLESS STEEL
	ungefärbt / monofil / nicht-resorbierbar	<i>undyed / monofilament / nonabsorbable</i>	NYLON, STAHL DRAHT STAINLESS STEEL

## Tips (Warnhinweise) / Suggestions

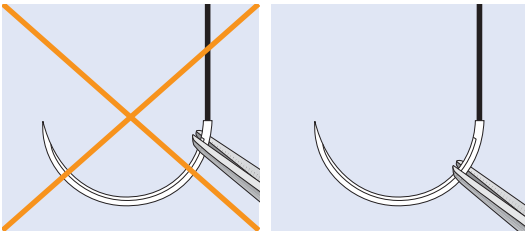

### Nadel fassen

Die Nadeln sollen in einer Distanz von ca. 3/4, von der Nadelspitze aus gesehen, gefaßt werden. Nicht an der Armierungszone fassen, damit diese und auch der Faden nicht verletzt werden.

### Holding the needle

Needles should be held approx. 3/4 away from the tip. Do not clamp where the suture is swaged to the needle to avoid weakening the needle and suture.

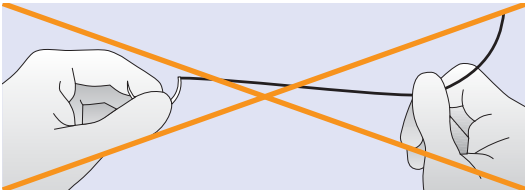

### Faden strecken

Faden nach Herausnahme sanft strecken! Nicht schnell ziehen oder reiben, nicht an der Nadel fassen und strecken!

### Straightening the suture

Straighten the suture gently after removal. Do not rub it or pull it quickly, do not hold the needle and stretch!

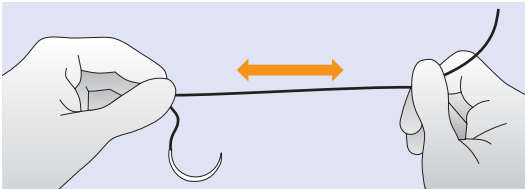

## Die Nadel / The Needle

Dürfen wir vorstellen: die chirurgische Nadel!  
May we introduce: the surgical needle!

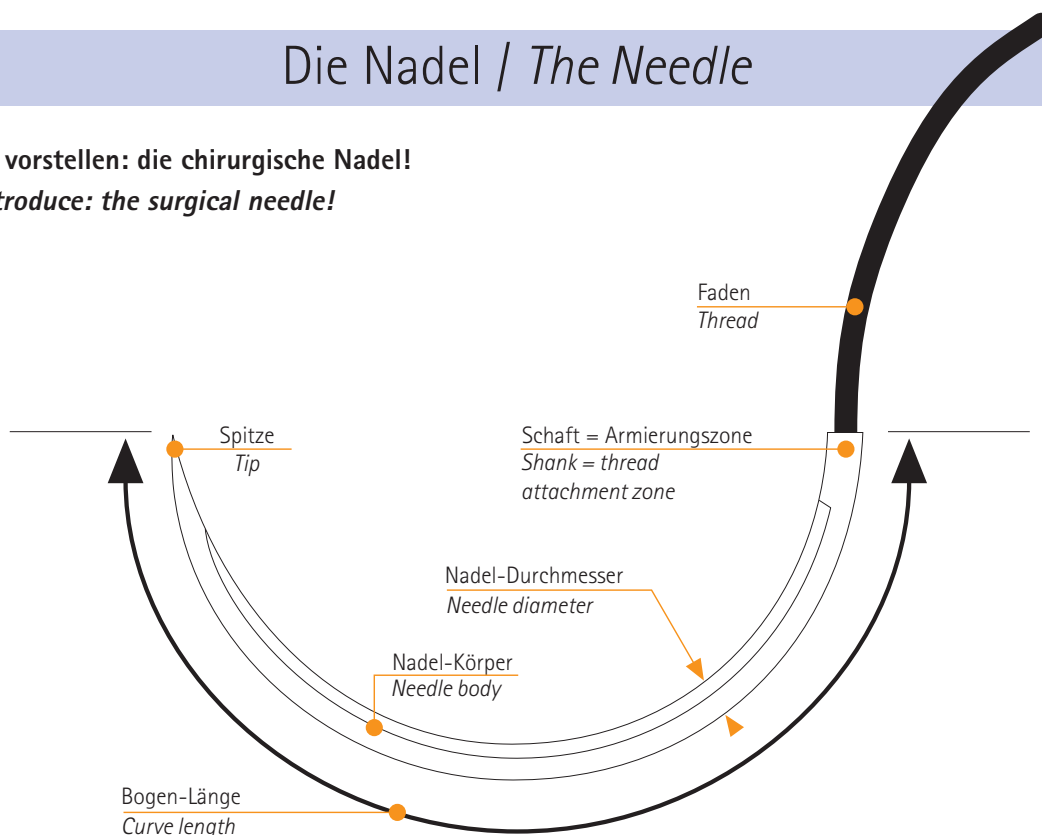

# Nadelcode / Needle code

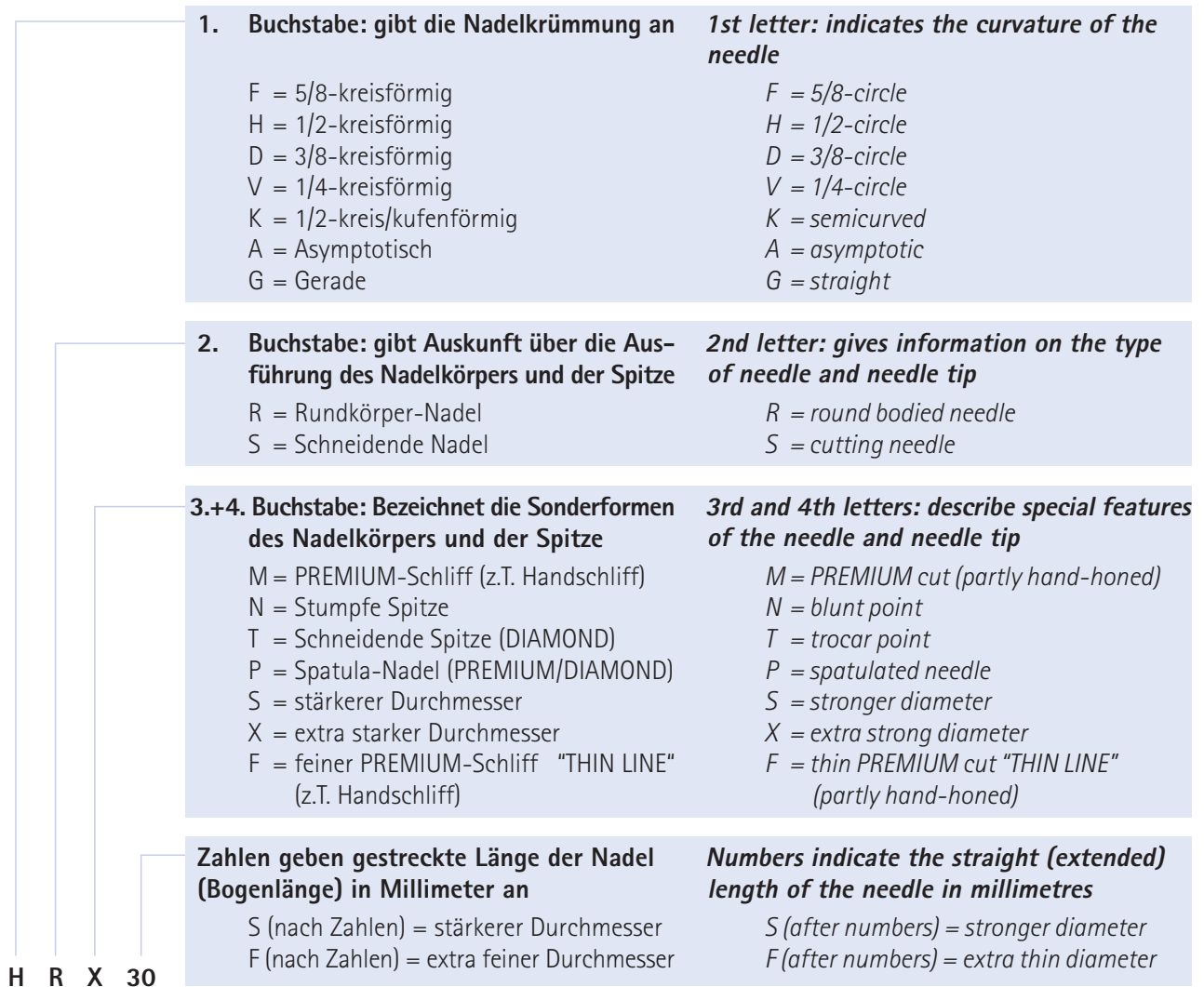

# Nadelkrümmung / Needle curvature

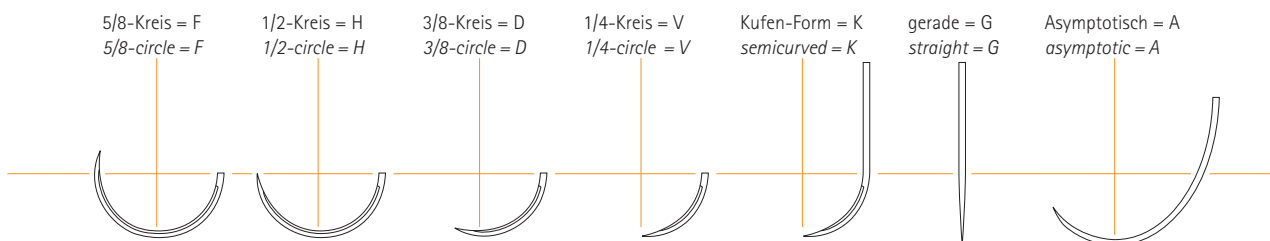

# Nadelformen / Needle shapes

## 1. Spatula Nadel ◻ = P

1/2-, 3/8- oder 1/4- kreisförmig  
oder gerade = HSPM, DSPM, VSPM

- Für Augen- und Mikrochirurgie
- Abgeflachter Nadelkörper
- PREMIUM-Schliff
- Seitlich schneidend

## 1. Spatula needle ◻ = P

1/2-circle, 3/8-circle, 1/4-circle,  
or straight = HSPM, DSPM, VSPM

- For use in ophthalmic surgery and microsurgery
- Needle cross-section flattened
- PREMIUM cut
- Cuts on lateral edges

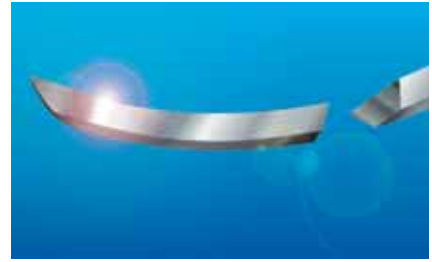

## 2. Stumpfe Rundkörpernadel ○ = RN

1/2-, 3/8- kreisförmig oder  
1/2-gebogen = HRN, DRN, KRN

- Für Parenchymgewebe, Cervix und Muskelzüge am Auge
- Stumpfe Nadelspitze
- Kein Durchstechen von Gefäßen oder Sehnen

## 2. Blunt round-bodied needle ○ = RN

1/2-circle, 3/8-circle or semicurved  
= HRN, DRN, KRN

- For use in parenchymal tissue, the cervix, and muscle traction in the eye
- Needle tip blunt
- No puncturing of vessels or tendons



## 3. Außen schneidende Nadel ▼ = S

1/2-, 3/8-kreisförmig, 1/2-gebogen  
oder gerade = HS, DS, KS, GS, FS

- Für festes Gewebe, wie z.B. Haut
- Dreieckiger Nadelquerschnitt
- z.T. mit PREMIUM-Schliff M, MF und MFX erhältlich

## 3. Reverse cutting needle ▼ = S

1/2-circle, 3/8-circle, semicurved  
or straight = HS, DS, KS, GS, FS

- For use in firm tissue such as skin
- Triangular needle cross-section
- Also available with PREMIUM cut needles M, MF, and MFX



## 4. Rundkörpernadel ● = R

5/8-, 1/2-, 3/8-kreisförmig oder  
gerade = FR, HR, DR, GR

- Für weiches Gewebe (subcutan), wie Muskel, Faszie, Schleimhaut
- Zum besseren Sitz des Nadelhalters ist der Nadelkörper im mittleren Bereich abgeflacht
- Leichter Einstich

## 4. Round-bodied needle ● = R

5/8-circle, 1/2-circle, 3/8-circle  
or straight = FR, HR, DR, GR

- For use in soft tissue (subcutaneous) such as muscle, fascia, mucosa
- In order to improve grip by the needle holder, the cross-section of the middle part of the needle is flattened
- Easy insertion



## 5. Schneidende Rundkörpernadel

◻● = RT

1/2-, 3/8-kreisförmig oder gerade  
= HRT, DRT, GRT, ART

- Für festes Gewebe, sklerotische Gefäße und Prothesen
- Nadelspitze dreikantig bzw. vierkantig geschliffen, daher enger Stichkanal, durchdringt Gewebe wie ▼-Nadel (z.T. mit PREMIUM-Schliff erhältlich)

## 5. Round-bodied cutting needle

◻● = RT

1/2-circle, 3/8-circle or straight  
= HRT, DRT, GRT, ART

- For use in firm tissue, sclerotic vessels, and implants
- Needle tip triangular or square in section, therefore small puncture channel, penetrates tissue like a ▼-needle (also available with PREMIUM cut)



# Nadelfolie / Needle foil

## Zur Identifizierung atraumatischer Nadeln

Die Nadelfolie erleichtert die Einordnung von chirurgischen Nadeln hinsichtlich Länge und Form. Legen Sie die Folie des Nadelprogramms über die zu bestimmende Nadelabbildung und lesen Sie die technischen Daten über den europäischen Nadelcode ab.

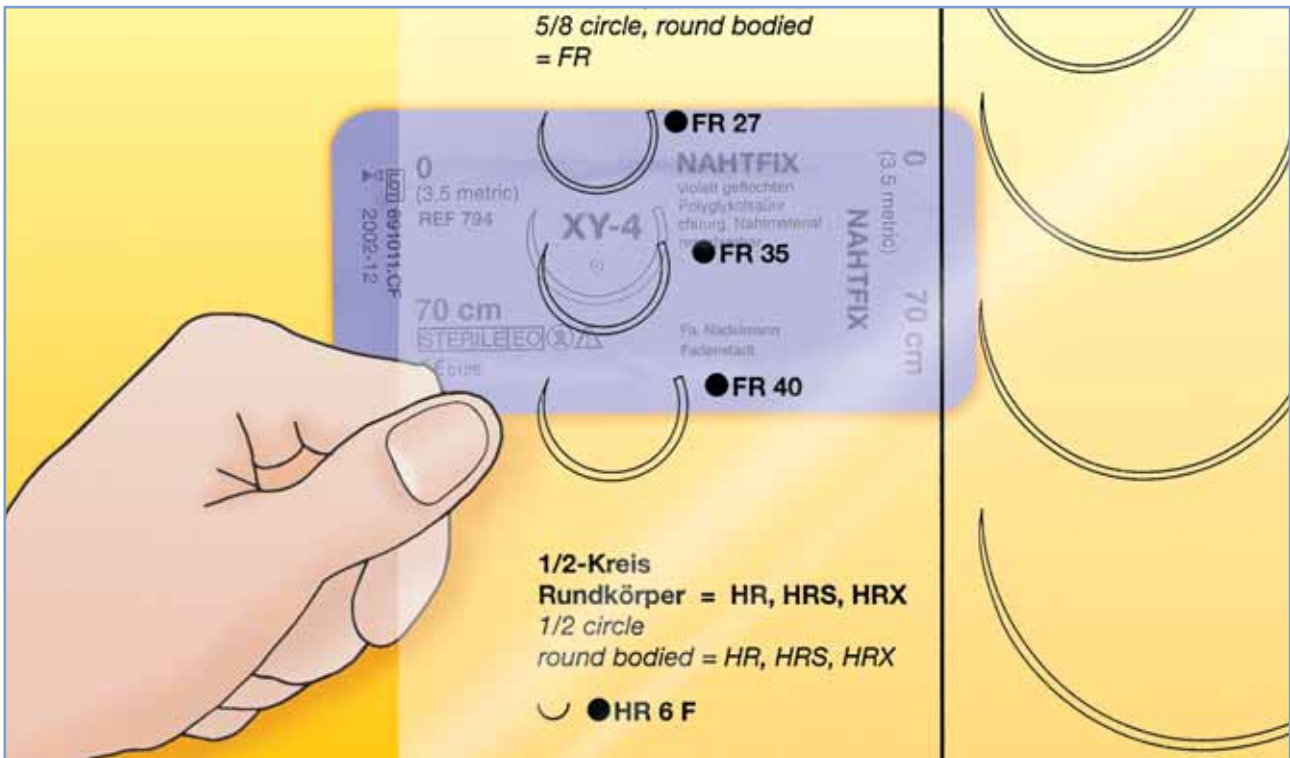

## Foil for identifying atraumatic needles

The foil enables the length and shape of any needle to be identified. Place the foil showing the range of needles over the needle you like to identify and read off the corresponding technical data and European code.















# Nadel-Programm / Needle range

**5/8-Kreis Rundkörper = FR**  
*5/8 circle, round bodied = FR*

- FR 27 
- FR 35 
- FR 40 

**1/2-Kreis Rundkörper = HR, HRS, HRX**  
*1/2 circle, round bodied = HR, HRS, HRX*

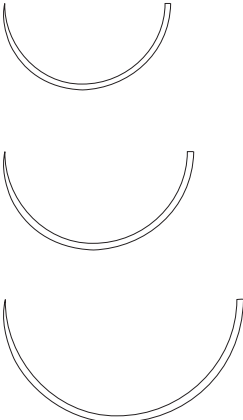
- HR 6 F 
- HR 6 
- HR 8 
- HR 10 
- HR 12 
- HR 15 
- HR 17 
- HR 22 
- HR 27 
- HR 30 
- HR 35 
- HR 40 
- HR 50 

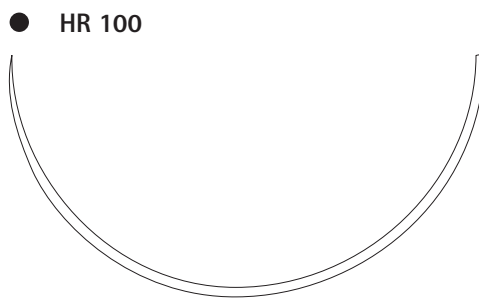
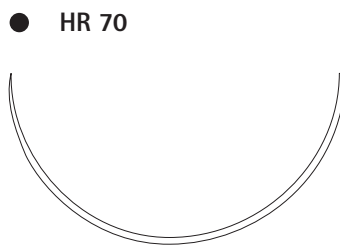

**1/2-Kreis Rundkörper stumpf = HRN**  
*1/2 circle, round bodied, blunt point = HRN*

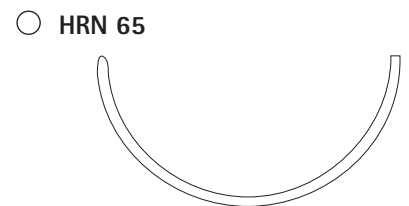
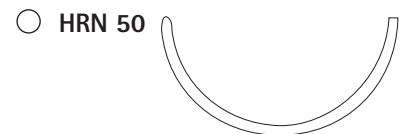

**Asymptotische schneidende Rundkörper = ART**  
*Asymptotic, round bodied, trocar point = ART*



# Nadel-Programm / Needle range

**1/2-Kreis schneidende Rundkörper (Diamond-Spitze) = HRT, HRTX**  
*1/2 circle round bodied, trocar point = HRT, HRTX*

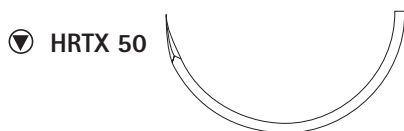

**3/8-Kreis Rundkörper = DR**  
*3/8 circle, round bodied = DR*



**3/8-Kreis Rundkörper Stumpf = DRN**  
*3/8 circle round bodied, blunt point = DRN*



**3/8-Kreis schneidende Rundkörper (Diamond-Spitze) = DRT, mit PREMIUM-Schliff = DRTM**  
*3/8 circle, round bodied, trocar point = DRT, with PREMIUM cut = DRTM*

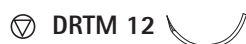

**1/2-Kreis außen schneidende = HS**  
*1/2-circle, reverse cutting = HS*

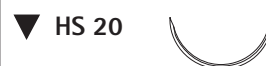

# Nadel-Programm / Needle range

1/2-Kreis außen schneidende,  
extra stark = HSX  
1/2 circle, reverse cutting, extra strong  
= HSX



1/2-Kreis außen schneidende mit  
PREMIUM-Schliff = HSM  
1/2 circle, cutting, with PREMIUM cut  
= HSM

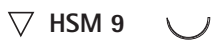

3/8-Kreis außen schneidende = DS  
mit PREMIUM-Schliff = DSM  
PREMIUM-Schliff Nadel  
"THIN LINE" = DSMF, DSMFX  
3/8 circle, cutting = DS  
PREMIUM cut = DSM  
PREMIUM cut "THIN LINE" = DSMF,  
DSMFX

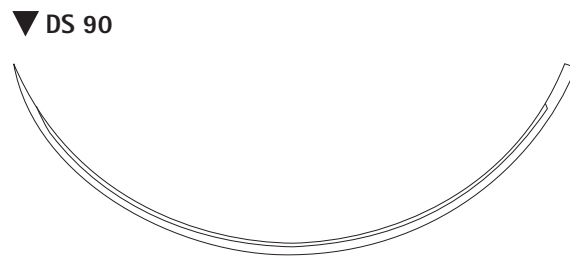
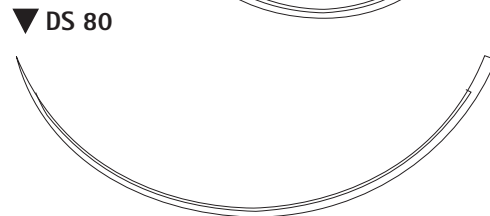

Präzisionsschliff  
precision cut

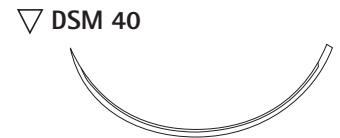

THIN LINE

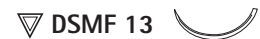

THIN LINE  
Sonderstärke  
extra strong

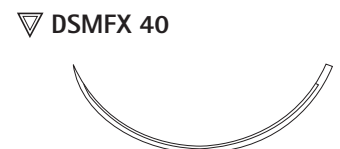
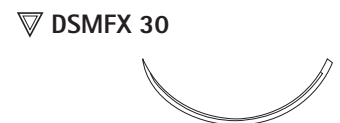
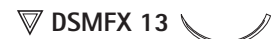



# Nadel-Programm / Needle range

**Gerade Rundkörper = GR**  
*straight, round bodied = GR*

● GR 20



● GR 45



● GR 51



● GR 65



● GRW 65



*biegsame Nadel / flexible*

**Gerade schneidende Rundkörper  
 (Diamond-Spitze) = GRT**  
*straight, round bodied,  
 trocar point = GRT*

▼ GRT 40



**Gerade schneidende = GS**  
*straight, cutting = GS*

▼ GS 12



▼ GS 45



▼ GS 50



▼ GS 60



**Gerade SPATULA = GRPM  
 (PREMIUM-Schliff)**  
*straight, spatulated = GRPM  
 (PREMIUM cut)*

▽ GRPM 16



**1/2-Kreis SPATULA = HSPM  
 (PREMIUM-Schliff)**  
*1/2 circle, spatulated = HSPM  
 (PREMIUM cut)*

▽ HSPM 5 P ◡ **(progressive Kurve)**  
*(progressive curve)*

▽ HSPM 6 F ◡

▽ HSPM 6 ◡

▽ HSPM 7 ◡

▽ HSPM 8 ◡

**3/8-Kreis SPATULA = DSPM  
 (PREMIUM-Schliff)**  
*3/8 circle, spatulated = DSPM  
 (PREMIUM cut)*

▽ DSPM 4 ◡

▽ DSPM 5 ◡

▽ DSPM 6 ◡

▽ DSPM 7 ◡

▽ DSPM 8 ◡

**1/4-Kreis SPATULA = VSPM  
 (PREMIUM-Schliff)**  
*1/4 circle, spatulated = VSPM  
 (PREMIUM cut)*

▽ VSPM 6 F ◡

▽ VSPM 6 ◡

▽ VSPM 7 ◡

▽ VSPM 8 F ◡

▽ VSPM 8 ◡

▽ VSPM 9 ◡

**1/2-gebogene außen schneidende = KS**  
*1/2 curved, reverse cutting = KS*

▼ KS 20 ◡



## Glycolon

Glycolon ist ein synthetisches und kurzfristig absorbierbares Nahtmaterial aus Polyglykolsäure - Caprolacton.

Der monofile Faden ist violett eingefärbt und ungefärbt erhältlich.

- kurzfristig absorbierbar, synthetisch
- gute Geschmeidigkeit
- hohe Reißkraft
- glatter Gewebedurchzug
- minimale Gewebereaktion
- guter Knotensitz

## Glycolon

*Glycolon is a synthetic and monofilament fast absorbable suture consisting of glycolic acid and caprolacton.*











*The suture is available violet and undyed.*

- *synthetic, fast absorbable suture*
- *permanent pliability*
- *high tensile strength*
- *smooth tissue passage*
- *minimal tissue reactions*
- *perfect knot security*

# GLYCOLON® PGA/PCL

## Sterile Nadel-Faden-Kombination







Needle - suture - combination, sterile

Nadel / needle	Stärke Nr. gauge no.		Länge/length m	Farbe/colour	Best.-Nr. code no.	Pckg.-Inhalt box content in Dtzd./dozen
	metric	USP				
<b>1/2-Kreis Rundkörper = HR, HRS</b> <i>1/2 circle, round bodied = HR, HRS</i>						
● HR12 	0.7	6-0	0,45	violett	PB40204	2
	1	5-0	0,45	violett	PB40200	2
● HR 17 	1	5-0	0,70	violett	PB40201	2
	1.5	4-0	0,70	violett	PB40202	2
	2	3-0	0,70	violett	PB40203	2
● 2x HR 17 	1	5-0	0,70	violett	PB40207	2
● HR 22 	1.5	4-0	0,70	violett	PB40215	2
	2	3-0	0,70	violett	PB40216	2
	3	2-0	0,70	violett	PB40217	2
● HR 27 	1.5	4-0	0,70	violett	PB40230	2
	2	3-0	0,70	violett	PB40231	2
	3	2-0	0,70	violett	PB40232	2
● 2x HR 27 	1.5	4-0	0,90	violett	PB40236	2
● HRS 27 	3.5	0	0,70	violett	PB40310	2
	4	1	0,90	violett	PB40313	2
● HR 35 	3	2-0	0,70	violett	PB40241	2
	3.5	0	0,70	violett	PB40242	2
● HRS 35 	3,5	0	0,90	violett	PB40324	2
	4	1	0,90	violett	PB40325	2
● HRS 40 	3,5	0	0,90	violett	PB40334	2
	4	1	0,90	violett	PB40335	2
● HRS 48 	4	1	0,90	violett	PB40343	2

# GLYCOLON® PGA/PCL

## Sterile Nadel-Faden-Kombination





Needle - suture - combination, sterile

Nadel / needle	Stärke Nr. gauge no.		Länge/length m	Farbe/colour	Best.-Nr. code no.	Pckg.-Inhalt box content in Dtzd./dozen
	metric	USP				
<b>1/2-Kreis schneidende Rundkörper (Diamond-Spitze) = HRT · 1/2 circle round bodied, trocar point = HRT</b>						
<b>▼ HRT16</b> 	1	5-0	0,45	violett	PB40602	2
<b>▼ HRT18</b> 	1,5	4-0	0,70	violett	PB40605	2
	2	3-0	0,70	violett	PB40606	2
<b>▼ HRT 25</b> 	3	2-0	0,70	violett	PB40620	2
<b>3/8-Kreis schneidende = DS mit PREMIUM-Schliff = DSM · 3/8 circle, reverse cutting = DS, PREMIUM cut = DSM</b>						
<b>▽ DSM 11</b> 	0,7	6-0	0,45	violett	PB41512	2
	0,7	6-0	0,45	ungefärbt/ undyed	PB41502	2
	1	5-0	0,45	violett	PB41501	2
<b>▽ DSM 13</b> 	0,7	6-0	0,45	ungefärbt/ undyed	PB41504	2
	1	5-0	0,45	violett	PB41503	2
	1	5-0	0,45	ungefärbt/ undyed	PB41505	2
	1	5-0	0,70	violett	PB41507	2
	1,5	4-0	0,45	violett	PB41508	2
	1,5	4-0	0,45	ungefärbt/ undyed	PB41506	2
<b>▽ DSM 16</b> 	1	5-0	0,45	violett	PB41509	2
	1,5	4-0	0,45	violett	PB41511	2
	1,5	4-0	0,45	ungefärbt/ undyed	PB41510	2
<b>▼ DS 18</b> 	1	5-0	0,45	violett	PB41421	2
	1	5-0	0,70	ungefärbt/ undyed	PB41410	2
	1,5	4-0	0,45	violett	PB41420	2
	1,5	4-0	0,45	ungefärbt/ undyed	PB41411	2
	1,5	4-0	0,70	violett	PB41416	2
	1,5	4-0	0,70	ungefärbt/ undyed	PB41414	2
	2	3-0	0,45	violett	PB41413	2
	2	3-0	0,45	ungefärbt/ undyed	PB41412	2
	2	3-0	0,70	ungefärbt/ undyed	PB41415	2

# GLYCOLON® PGA/PCL

## Sterile Nadel-Faden-Kombination

Needle - suture - combination, sterile

Nadel / needle	Stärke Nr. gauge no.		Länge/length m	Farbe/colour	Best.-Nr. code no.	Pckg.-Inhalt box content in Dtzd./dozen
	metric	USP				
<b>3/8-Kreis schneidende = DS mit PREMIUM-Schliff = DSM</b> <i>3/8 circle, reverse cutting = DS PREMIUM cut = DSM</i>						
<b>▽ DSM 18</b> 	1	5-0	0,45	ungefärbt/ undyed	PB41516	2
	1,5	4-0	0,45	ungefärbt/ undyed	PB41513	2
	1,5	4-0	0,70	violett	PB41515	2
	1,5	4-0	0,70	ungefärbt/ undyed	PB41522	2
	2	3-0	0,45	ungefärbt/ undyed	PB41514	2
<b>▼ DS 21</b> 	1,5	4-0	0,70	violett	PB41417	2
<b>▼ DS 24</b> 	2	3-0	0,70	ungefärbt/ undyed	PB41418	2
	3	2-0	0,70	ungefärbt/ undyed	PB41419	2
<b>▽ DSM 24</b> 	2	3-0	0,70	ungefärbt/ undyed	PB41520	2
	3	2-0	0,70	ungefärbt/ undyed	PB41521	2

# GLYCOLON® PGA/PCL

## Einzelfadenpackungen, steril in vorgeschnittenen Längen

Sterile pre-cut suture, non-needed

	Stärke Nr. gauge no.		Länge/length m	Farbe/colour	Best.-Nr. code no.	Pckg.-Inhalt box content in Dtzd./dozen
	metric	USP				
	1,5	4-0	3x 0,45	ungefärbt/ undyed	PT333	2
	2	3-0	3x 0,45	ungefärbt/ undyed	PT433	2
	3	2-0	3x 0,45	ungefärbt/ undyed	PT533	2

## PGA Resoquick

PGA Resoquick ist ein synthetisches, kurzfristig absorbierbares Nahtmaterial bestehend aus Polyglykolsäure. Zur Reduzierung der Reibung ist der geflochtene Faden mit Resolacton beschichtet. Diese Beschichtung ist inert, nicht antigen und nicht pyrogen.

- synthetisch, kurzfristig absorbierbar
- gute Geschmeidigkeit
- hohe Reißkraft
- minimale Gewebereaktion
- glatter Gewebedurchzug
- guter Knotensitz

## PGA Resoquick







*PGA Resoquick is a synthetic, fast absorbable suture consisting of glycolic acid. To reduce friction the braided thread is finished with a coating of Resolacton. This coating is inert, non-antigenic, and apyrogenic.*

- *synthetic, fast absorbable suture*
- *permanent pliability*
- *high tensile strength*
- *minimal tissue reactions*
- *smooth tissue passage*
- *perfect knot security*

# PGA Resoquick Polyglykolsäure

## Sterile Nadel-Faden-Kombination





Needle - suture - combination, sterile

Nadel / needle	Stärke Nr. gauge no.		Länge/length m	Farbe/colour	Best.-Nr. code no.	Pckg.-Inhalt box content in Dtzd./dozen
	metric	USP				
<b>5/8-Kreis Rundkörper = FR</b> 5/8 circle, round bodied = FR						
● FR 35 	3	2-0	0,70	ungefärbt/ undyed	PR30103	2
<b>1/2-Kreis Rundkörper = HR, HRS</b> 1/2 circle, round bodied = HR, HRS						
● HR 17 	1	5-0	0,70	ungefärbt/ undyed	PR30203	2
	1.5	4-0	0,70	ungefärbt/ undyed	PR30204	2
	2	3-0	0,70	ungefärbt/ undyed	PR30205	2
● HR 22 	1.5	4-0	0,70	ungefärbt/ undyed	PR30208	2
	2	3-0	0,70	ungefärbt/ undyed	PR30209	2
	3	2-0	0,70	ungefärbt/ undyed	PR30210	2
● HR 27 	1.5	4-0	0,70	ungefärbt/ undyed	PR30213	2
	2	3-0	0,70	ungefärbt/ undyed	PR30214	2
	3	2-0	0,70	ungefärbt/ undyed	PR30215	2
	3.5	0	0,70	ungefärbt/ undyed	PR30216	2
● HRS 27 	3	2-0	0,70	ungefärbt/ undyed	PR30303	2
	3.5	0	0,70	ungefärbt/ undyed	PR30304	2
	4	1	0,70	ungefärbt/ undyed	PR30305	2
● HRS 35 	3	2-0	0,90	ungefärbt/ undyed	PR30308	2
	3.5	0	0,90	ungefärbt/ undyed	PR30309	2
	4	1	0,90	ungefärbt/ undyed	PR30310	2

# PGA Resoquick Polyglykolsäure

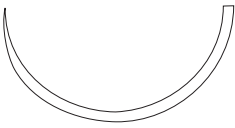
## Sterile Nadel-Faden-Kombination

Needle - suture - combination, sterile









Nadel / needle	Stärke Nr. gauge no.		Länge/length m	Farbe/colour	Best.-Nr. code no.	Pckg.-Inhalt box content in Dtzd./dozen
	metric	USP				
<b>1/2-Kreis Rundkörper = HR, HRS</b> <i>1/2 circle, round bodied = HR, HRS</i>						
● HRS 40 	3.5	0	0,90	ungefärbt/ undyed	PR30313	2
	4	1	0,90	ungefärbt/ undyed	PR30314	2
● HRS 48 	4	1	0,90	ungefärbt/ undyed	PR30317	2
<b>1/2-Kreis schneidende Rundkörper (Diamond-Spitze) = HRT</b> <i>1/2 circle round bodied, trocar point = HRT</i>						
▼ HRT 25 A  <i>Abziehnadel / control release needle</i>	2	3-0	5 x 0,45	ungefärbt/ undyed	PR30605	1
▼ HRT 35 	3	2-0	0,90	ungefärbt/ undyed	PR30608	2
	3.5	0	0,90	ungefärbt/ undyed	PR30609	2
	4	1	0,90	ungefärbt/ undyed	PR30610	2
<b>1/2-Kreis schneidende = HS</b> <i>1/2 circle, reverse cutting = HS</i>						
▼ HS 18 	1.5	4-0	0,45	ungefärbt/ undyed	PR31103	2
	2	3-0	0,45	ungefärbt/ undyed	PR31104	2
▼ HS 22 	2	3-0	0,45	ungefärbt/ undyed	PR31107	2
	3	2-0	0,45	ungefärbt/ undyed	PR31108	2



# PGA Resoquick Polyglykolsäure

## Sterile Nadel-Faden-Kombination

Needle - suture - combination, sterile

Nadel / needle	Stärke Nr. gauge no.		Länge/length m	Farbe/colour	Best.-Nr. code no.	Pckg.-Inhalt box content in Dtzd./dozen
	metric	USP				
<b>3/8-Kreis schneidende = DS mit PREMIUM-Schliff = DSM</b> <i>3/8 circle, reverse cutting = DS PREMIUM cut = DSM</i>						
 <b>DSM 11</b> PREMIUM-Schliff / PREMIUM cut	0.7	6-0	0,45	ungefärbt/ undyed	PR31502	2
 <b>DSM 13</b> PREMIUM-Schliff / PREMIUM cut	1	5-0	0,45	ungefärbt/ undyed	PR31504	2
	1.5	4-0	0,45	ungefärbt/ undyed	PR31505	2
 <b>DS 18</b>	1	5-0	0,45	ungefärbt/ undyed	PR31405	2
	2	3-0	0,45	ungefärbt/ undyed	PR31408	2
 <b>DS 18 F</b>	1.5	4-0	0,45	ungefärbt/ undyed	PR31410	2
 <b>DSM 18 F</b> PREMIUM-Schliff / PREMIUM cut	1.5	4-0	0,45	ungefärbt/ undyed	PR31516	2
	1.5	4-0	0,70	ungefärbt/ undyed	PR31517	2
 <b>DSM 18</b> PREMIUM-Schliff / PREMIUM cut	1.5	4-0	0,70	ungefärbt/ undyed	PR31509	2
	2	3-0	0,45	ungefärbt/ undyed	PR31510	2
	2	3-0	0,70	ungefärbt/ undyed	PR31511	2
 <b>DS 24</b>	2	3-0	0,45	ungefärbt/ undyed	PR31420	2
	2	3-0	0,70	ungefärbt/ undyed	PR31421	2
	3	2-0	0,45	ungefärbt/ undyed	PR31422	2
 <b>DSM 24</b> PREMIUM-Schliff / PREMIUM cut	2	3-0	0,45	ungefärbt/ undyed	PR31520	2
	2	3-0	0,70	ungefärbt/ undyed	PR31521	2
	3	2-0	0,45	ungefärbt/ undyed	PR31522	2
	3	2-0	0,70	ungefärbt/ undyed	PR31523	2

# PGA Resoquick Polyglykolsäure

## Sterile Nadel-Faden-Kombination

Needle - suture - combination, sterile

	Stärke Nr. gauge no. metric	USP	Länge/length m	Farbe/colour	Best.-Nr. code no.	Pckg.-Inhalt box content in Dtzd./dozen
<b>Gerade schneidende = GS</b> <i>straight, cutting = GS</i>						
▼ <b>GS 12</b> 	1.5	4-0	0,45	ungefärbt/ <i>undyed</i>	PR31703	2

# PGA Resoquick Polyglykolsäure

## Einzelfadenpackungen, steril in vorgeschrittenen Längen

*Sterile pre-cut suture, non-neededled*

Stärke Nr. gauge no. metric		USP	Länge/length m	Farbe/colour	Best.-Nr. code no.	Pckg.-Inhalt box content in Dtzd./dozen
2	3-0		3 x 0,45	ungefärbt/ undyed	PW 433	2
3	2-0		3 x 0,45	ungefärbt/ undyed	PW 533	2
3.5	0		3 x 0,45	ungefärbt/ undyed	PW 633	2
2	3-0		6 x 0,45	ungefärbt/ undyed	PW 465	2
3	2-0		6 x 0,45	ungefärbt/ undyed	PW 565	2
3.5	0		6 x 0,45	ungefärbt/ undyed	PW 665	2
4	1		6 x 0,45	ungefärbt/ undyed	PW 765	2
3	2-0		2 x 0,70	ungefärbt/ undyed	PW 520	2
3.5	0		2 x 0,70	ungefärbt/ undyed	PW 620	2
4	1		2 x 0,70	ungefärbt/ undyed	PW 720	2

## PGA Resorba

PGA  
Resorba

PGA Resorba® ist ein synthetisches absorbierbares Nahtmaterial bestehend aus Glykolsäure. Der geflochtene Faden wird zur Reduzierung der Reibung mit einer Beschichtung aus Resolacton versehen. Die Beschichtung ist inert, nicht antigen und nicht pyrogen. Violettes PGA Resorba® wird während der Polymerisation eingefärbt.

- synthetisch absorbierbar
- gute Geschmeidigkeit
- hohe Reißkraft
- minimale Gewebereaktion
- glatter Gewebedurchzug
- guter Knotensitz

## PGA Resorba







*PGA Resorba® is a synthetic absorbable suture consisting of glycolic acid. The braided thread is finished with a coating of Resolacton to reduce friction. This coating is inert, non-antigenic, and apyrogenic. Violet PGA Resorba® is dyed during polymerisation.*

- *synthetic absorbable suture*
- *permanent pliability*
- *high tensile strength*
- *minimal tissue reactions*
- *smooth tissue passage*
- *perfect knot security*

# PGA RESORBA® Polyglykolsäure

## Sterile Nadel-Faden-Kombination







Needle - suture - combination, sterile

Nadel / needle	Stärke Nr. gauge no.		Länge/length m	Farbe/colour	Best.-Nr. code no.	Pckg.-Inhalt box content in Dtzd./dozen
	metric	USP				
<b>5/8-Kreis Rundkörper = FR</b> 5/8 circle, round bodied = FR						
● FR 27 	2	3-0	0,70	violett/violet	PA 1011	2
	3.5	0	0,70	violett/violet	PA 1015	2
● FR 35 	3.5	0	0,70	violett/violet	PA 1013	2
	4	1	0,70	violett/violet	PA 1014	2
	3.5	0	6 x 0,70	violett/violet	PA 1017	1
					Multipack	
● 2 x FR 35 	3	2-0	0,70	violett/violet	PA 1012	2
	3.5	0	0,90	violett/violet	PA 1018	2
● FR 40 	3.5	0	0,70	violett/violet	PA 1016	2
<b>1/2-Kreis Rundkörper = HR, HRS, HRX</b> 1/2 circle, round bodied = HR, HRS, HRX						
● HR 10 	1	5-0	0,70	ungefärbt/ undyed	PA 10262	2
● HR 12 	0.7	6-0	0,45	violett/violet	PA 10273	2
	1	5-0	0,45	violett/violet	PA 10274	2
	0.7	6-0	0,70	violett/violet	PA 1021	2
	1	5-0	0,70	violett/violet	PA 1022	2
	1.5	4-0	0,70	violett/violet	PA 1023	2
	0.7	6-0	0,70	ungefärbt/ undyed	PA 10242	2
	1	5-0	0,70	ungefärbt/ undyed	PA 10265	2
	1.5	4-0	0,70	ungefärbt/ undyed	PA 10266	2
● HRS 12 	2	3-0	0,70	violett/violet	PA 10328	2
	3	2-0	0,70	violett/violet	PA 10329	2
	3.5	0	0,70	violett/violet	PA 10330	2

# PGA RESORBA® Polyglykolsäure

## Sterile Nadel-Faden-Kombination



Needle - suture - combination, sterile

Nadel / needle	Stärke Nr. gauge no.		Länge/length m	Farbe/colour	Best.-Nr. code no.	Pckg.-Inhalt box content in Dtzd./dozen
	metric	USP				
<b>● HR 17</b> 	1	5-0	0,70	violett/violet	PA 1024	2
	1.5	4-0	0,70	violett/violet	PA 1025	2
	2	3-0	0,70	violett/violet	PA 1026	2
	3	2-0	0,70	violett/violet	PA 1027	2
	1	5-0	0,70	ungefärbt/ undyed	PA 10248	2
	1.5	4-0	0,70	ungefärbt/ undyed	PA 10243	2
	2	3-0	0,70	ungefärbt/ undyed	PA 10244	2
	3	2-0	0,70	ungefärbt/ undyed	PA 10258	2
<b>● HR 17 A</b>  Abziehnadel / control release needle	1	5-0	4 x 0,45	violett/violet	PA 10256 Multipack	1
	1.5	4-0	8 x 0,45	violett/violet	PA 1028 Multipack	1
	2	3-0	8 x 0,45	violett/violet	PA 1029 Multipack	1
<b>● HR 22</b> 	1.5	4-0	0,70	violett/violet	PA 10210	2
	2	3-0	0,70	violett/violet	PA 10211	2
	3	2-0	0,70	violett/violet	PA 10212	2
	2	3-0	0,70	ungefärbt/ undyed	PA 10254	2
	3	2-0	0,70	ungefärbt/ undyed	PA 10255	2
<b>● HR 22 A</b>  Abziehnadel / control release needle	1.5	4-0	8 x 0,45	violett/violet	PA 10213 Multipack	1
	2	3-0	8 x 0,45	violett/violet	PA 10214 Multipack	1
	3	2-0	8 x 0,45	violett/violet	PA 10215 Multipack	1
	2	3-0	4 x 0,70	violett/violet	PA 10241 Multipack	1
	1.5	4-0	4 x 0,45	violett/violet	PA 10252 Multipack	1
	3	2-0	4 x 0,45	violett/violet	PA 10276 Multipack	1
<b>● HRS 22</b> 	3	2-0	0,70	violett/violet	PA 10331	2
	3.5	0	0,70	violett/violet	PA 10332	2
	4	1	0,70	violett/violet	PA 10333	2
	3	2-0	0,90	violett/violet	PA 10367	2
<b>● HRS 22 A</b>  Abziehnadel / control release needle	3.5	0	4 x 0,70	violett/violet	PA 10357 Multipack	1

# PGA RESORBA® Polyglykolsäure

## Sterile Nadel-Faden-Kombination







Needle - suture - combination, sterile

Nadel / needle	Stärke Nr. gauge no.		Länge/length m	Farbe/colour	Best.-Nr. code no.	Pckg.-Inhalt box content in Dtzd./dozen	
	metric	USP					
<p>● HR 27</p> 	1.5	4-0	0,70	violett/violet	PA 10216	2	
	2	3-0	0,70	violett/violet	PA 10217	2	
	3	2-0	0,70	violett/violet	PA 10218	2	
	3.5	0	0,70	violett/violet	PA 10219	2	
	1.5	4-0	0,90	violett/violet	PA 10220	2	
	2	3-0	0,90	violett/violet	PA 10221	2	
	3	2-0	0,90	violett/violet	PA 10222	2	
	3.5	0	0,90	violett/violet	PA 10223	2	
	2	3-0	0,70	ungefärbt/ undyed	PA 10250	2	
	3	2-0	0,70	ungefärbt/ undyed	PA 10251	2	
	3.5	0	0,70	ungefärbt/ undyed	PA 10253	2	
	3	2-0	6 x 0,70	violett/violet	PA 10249 Multipack	1	
	<p>● HR 27 A</p>  <p>Abziehnadel / control release needle</p>	1.5	4-0	8 x 0,45	violett/violet	PA 10224 Multipack	1
2		3-0	8 x 0,45	violett/violet	PA 10225 Multipack	1	
3		2-0	8 x 0,45	violett/violet	PA 10226 Multipack	1	
1.5		4-0	4 x 0,45	violett/violet	PA 10227 Multipack	1	
2		3-0	4 x 0,45	violett/violet	PA 10228 Multipack	1	
3		2-0	4 x 0,45	violett/violet	PA 10229 Multipack	1	
2		3-0	0,70	violett/violet	PA 10280	2	
1.5		4-0	4 x 0,70	violett/violet	PA 10230 Multipack	1	
2		3-0	4 x 0,70	violett/violet	PA 10231 Multipack	1	
3		2-0	4 x 0,70	violett/violet	PA 10232 Multipack	1	
3.5		0	4 x 0,70	violett/violet	PA 10261 Multipack	1	
2		3-0	4 x 0,45	ungefärbt/ undyed	PA 10263 Multipack	1	
3		2-0	4 x 0,45	ungefärbt/ undyed	PA 10264 Multipack	1	
<p>● HRS 27</p> 		3	2-0	0,70	violett/violet	PA 1030	2
		3.5	0	0,70	violett/violet	PA 1031	2
	4	1	0,70	violett/violet	PA 1032	2	
	5	2	0,70	violett/violet	PA 10334	2	
	3	2-0	0,90	violett/violet	PA 10335	2	
	3.5	0	0,90	violett/violet	PA 1033	2	
	4	1	0,90	violett/violet	PA 1034	2	
	5	2	0,90	violett/violet	PA 1035	2	
	4	1	4 x 0,70	violett/violet	PA 10364 Multipack	1	
	5	2	4 x 0,70	violett/violet	PA 10351 Multipack	1	
	3	2-0	0,70	ungefärbt/ undyed	PA 10353	2	

# PGA RESORBA® Polyglykolsäure

## Sterile Nadel-Faden-Kombination

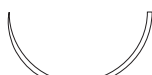
Needle - suture - combination, sterile





Nadel / needle	Stärke Nr. gauge no.		Länge/length m	Farbe/colour	Best.-Nr. code no.	Pckg.-Inhalt box content in Dtzd./dozen
	metric	USP				
<b>● HRS 27 A</b>  Abziehnadel / control release needle	3	2-0	4 x 0,45	violett/violet	PA 10336 Multipack	1
	3.5	0	4 x 0,45	violett/violet	PA 10337 Multipack	1
	4	1	4 x 0,45	violett/violet	PA 10338 Multipack	1
	3.5	0	4 x 0,70	violett/violet	PA 10339 Multipack	1
	4	1	4 x 0,70	violett/violet	PA 10340 Multipack	1
	5	2	4 x 0,70	violett/violet	PA 10341 Multipack	1
	3.5	0	8 x 0,45	violett/violet	PA 10348 Multipack	1
	4	1	8 x 0,45	violett/violet	PA 10372 Multipack	1
<b>● HRX 27</b> 	4	1	0,90	violett/violet	PA 1041	2
<b>● HRX 27 A</b>  Abziehnadel / control release needle	4	1	4 x 0,70	violett/violet	PA 1045 Multipack	1
<b>● HR 30</b> 	2	3-0	0,70	violett/violet	PA 10245	2
	3	2-0	0,70	violett/violet	PA 10233	2
	3.5	0	0,70	violett/violet	PA 10234	2
<b>● HR 30 A</b>  Abziehnadel / control release needle	3.5	0	4 x 0,70	violett/violet	PA 10270 Multipack	1
<b>● HRX 30</b> 	4	1	0,90	violett/violet	PA 1042	2
	5	2	0,90	violett/violet	PA 1043	2
<b>● HR 35</b> 	2	3-0	0,70	violett/violet	PA 10246	2
	3	2-0	0,70	violett/violet	PA 10235	2
	3.5	0	0,70	violett/violet	PA 10236	2
	4	1	0,70	violett/violet	PA 10237	2
	2	3-0	0,90	violett/violet	PA 10247	2
	3	2-0	0,90	violett/violet	PA 10238	2
	3.5	0	0,90	violett/violet	PA 10239	2
	4	1	0,90	violett/violet	PA 10240	2
	2	3-0	0,70	ungefärbt/ undyed	PA 10272	2



# PGA RESORBA® Polyglykolsäure

## Sterile Nadel-Faden-Kombination





Needle - suture - combination, sterile





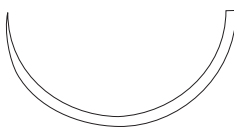
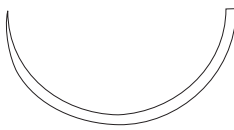

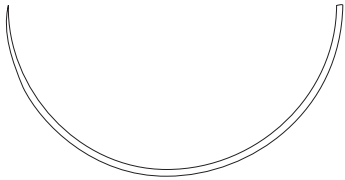
Nadel / needle	Stärke Nr. gauge no.		Länge/length m	Farbe/colour	Best.-Nr. code no.	Pckg.-Inhalt box content in Dtzd./dozen	
	metric	USP					
<b>● HR 35 A</b>  Abziehnadel / control release needle	2	3-0	4 x 0,45	violett/violet	PA 10277 Multipack	1	
	3	2-0	8 x 0,70	violett/violet	PA 10269 Multipack	1	
	3.5	0	4 x 0,70	violett/violet	PA 10267 Multipack	1	
<b>● HRS 35</b> 	3	2-0	0,70	violett/violet	PA 1037	2	
	3.5	0	0,70	violett/violet	PA 1038	2	
	4	1	0,70	violett/violet	PA 1039	2	
	2	3-0	0,90	violett/violet	PA 10371	2	
	3	2-0	0,90	violett/violet	PA 10310	2	
	3.5	0	0,90	violett/violet	PA 10311	2	
	4	1	0,90	violett/violet	PA 10312	2	
	5	2	0,90	violett/violet	PA 10313	2	
	3	2-0	0,90	ungefärbt/ undyed	PA 10349	2	
<b>● HRS 35 A</b>  Abziehnadel / control release needle	3.5	0	4 x 0,45	violett/violet	PA 10314 Multipack	1	
	4	1	4 x 0,45	violett/violet	PA 10315 Multipack	1	
	5	2	4 x 0,45	violett/violet	PA 10316 Multipack	1	
	3.5	0	8 x 0,50	violett/violet	PA 10324 Multipack	1	
	3.5	0	4 x 0,70	violett/violet	PA 10342 Multipack	1	
	4	1	4 x 0,70	violett/violet	PA 10343 Multipack	1	
	5	2	4 x 0,70	violett/violet	PA 10344 Multipack	1	
	4	1	4 x 0,90	violett/violet	PA 10350 Multipack	1	
	3.5	0	4 x 0,45	ungefärbt/ undyed	PA 10360 Multipack	1	
	4	1	4 x 0,45	ungefärbt/ undyed	PA 10361 Multipack	1	
	<b>● HRX 35</b> 	4	1	0,70	violett/violet	PA 1046	2
		4	1	0,90	violett/violet	PA 1044	2
	<b>● HRS 40</b> 	3	2-0	0,70	violett/violet	PA 10370	2
3.5		0	0,70	violett/violet	PA 10317	2	
4		1	0,70	violett/violet	PA 10318	2	
3.5		0	0,90	violett/violet	PA 10319	2	
4		1	0,90	violett/violet	PA 10320	2	
5		2	0,90	violett/violet	PA 10321	2	
4		1	1,50	violett/violet	PA 10322	2	
3.5		0	Schlinge/loop 0,70	ungefärbt/ undyed	PA 10355	2	
3.5		0	0,90	ungefärbt/ undyed	PA 10362	2	
4		1	0,90	ungefärbt/ undyed	PA 10363	2	

# PGA RESORBA® Polyglykolsäure

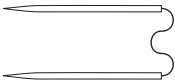
## Sterile Nadel-Faden-Kombination

Needle - suture - combination, sterile









Nadel / needle	Stärke Nr. gauge no.		Länge/length m	Farbe/colour	Best.-Nr. code no.	Pckg.-Inhalt box content in Dtzd./dozen
	metric	USP				
<b>● HRS 40 A</b>  Abziehnadel / control release needle	4	1	4 x 0,45	violett/violet	PA 10323 Multipack	1
	5	2	4 x 0,45	violett/violet	PA 10345 Multipack	1
	3	2-0	8 x 0,45	violett/violet	PA 10365 Multipack	1
	4	1	8 x 0,45	violett/violet	PA 10373 Multipack	1
<b>● HRS 48</b> 	2	3-0	0,70	violett/violet	PA 10359	2
	3	2-0	0,70	violett/violet	PA 10368	2
	3.5	0	0,90	violett/violet	PA 10325	2
	4	1	0,90	violett/violet	PA 10326	2
	5	2	0,90	violett/violet	PA 10327	2
	5	2	1,20	violett/violet	PA 10354	2
	3.5	0	1,50	violett/violet	PA 10366	2
	4	1	Schlinge/loop 1,50	violett/violet	PA 10352	2
	4	1	Schlinge/loop 0,70	ungefärbt/ undyed	PA 10356	2
	<b>● HRS 48 A</b>  Abziehnadel / control release needle	4	1	4 x 0,45	violett/violet	PA 10346 Multipack
5		2	4 x 0,45	violett/violet	PA 10347 Multipack	1
5		2	8 x 0,45	violett/violet	PA 10369 Multipack	1
4		1	4 x 0,70	violett/violet	PA 10358 Multipack	1
<b>● HR 50</b> 	3	2-0	0,70	violett/violet	PA 10281	2
	4	1	0,70	violett/violet	PA 10278	2
	3.5	0	0,90	violett/violet	PA 10279	2
	6	4	0,90	violett/violet	PA 10271	1
<b>● HR 70</b> 	2	3-0	0,70	violett/violet	PA 10275	2
	3	2-0	0,70	violett/violet	PA 10257	2
	3.5	0	0,70	violett/violet	PA 10259	2
	4	1	0,70	violett/violet	PA 10260	2
	4	1	1,20	violett/violet	PA 10268	2
<b>1/2-Kreis Rundkörper stumpf = HRN</b> 1/2 circle round bodied, blunt point = HRN						
<b>○ HRN 50</b> 	4	1	0,90	violett/violet	PA 1051	2





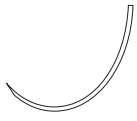

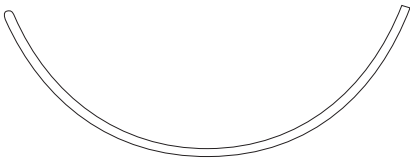

Nadel / needle	Stärke Nr. gauge no.		Länge/length m	Farbe/colour	Best.-Nr. code no.	Pckg.-Inhalt box content in Dtzd./dozen
	metric	USP				
<b>Gerade Rundkörper = GR</b> <i>straight, round bodied = GR</i>						
● 2 x GR 20 	1.5	4-0	0,35	violett/violet	PA 1091	2
<b>1/2-Kreis schneidende Rundkörper (Diamond-Spitze) = HRT, HRTX</b> <i>1/2 circle round bodied, trocar point = HRT, HRTX</i>						
▼ HRT 18 	1.5	4-0	0,70	violett/violet	PA 1060	2
	2	3-0	0,70	violett/violet	PA 1061	2
	3	2-0	0,70	violett/violet	PA 10615	2
	3.5	0	0,70	violett/violet	PA 10616	2
	1.5	4-0	0,70	ungefärbt/ undyed	PA 10621	2
2	3-0	0,70	ungefärbt/ undyed	PA 10613	2	
▼ HRT 18 A  <i>Abziehnadel / control release needle</i>	3	2-0	6 x 0,45	violett/violet	PA 10620 Multipack	1
▼ HRT 22 	2	3-0	0,70	ungefärbt/ undyed	PA 10625	2
	3	2-0	0,70	ungefärbt/ undyed	PA 10629	2
▼ HRT 22 A  <i>Abziehnadel / control release needle</i>	3	2-0	4 x 0,45	violett/violet	PA 1068 Multipack	1
▼ HRT 25 	2	3-0	0,70	violett/violet	PA 1064	2
	3	2-0	0,70	violett/violet	PA 1065	2
	3.5	0	0,70	violett/violet	PA 1066	2
	4	1	0,90	violett/violet	PA 1067	2
	2	3-0	0,70	ungefärbt/ undyed	PA 10622	2
	3	2-0	0,70	ungefärbt/ undyed	PA 10628	2
▼ HRT 25 A  <i>Abziehnadel / control release needle</i>	3.5	0	4 x 0,70	violett/violet	PA 10614 Multipack	1
	2	3-0	4 x 0,45	ungefärbt/ undyed	PA 10630 Multipack	1
	3	2-0	4 x 0,45	ungefärbt/ undyed	PA 10631 Multipack	1

# PGA RESORBA® Polyglykolsäure

## Sterile Nadel-Faden-Kombination

Needle - suture - combination, sterile







Nadel / needle	Stärke Nr. gauge no.		Länge/length m	Farbe/colour	Best.-Nr. code no.	Pckg.-Inhalt box content in Dtzd./dozen
	metric	USP				
 <p><b>HRT 35</b></p>	3	2-0	0,90	violett/violet	PA 10610	2
	3.5	0	0,90	violett/violet	PA 10611	2
	4	1	0,90	violett/violet	PA 10612	2
	5	2	0,90	violett/violet	PA 10624	2
	3	2-0	0,90	ungefärbt/ undyed	PA 10623	2
	3	2-0	1,00	ungefärbt/ undyed	PA 1069	2
 <p><b>HRT 35 A</b></p> <p>Abziehnadel / control release needle</p>	4	1	4 x 0,45	violett/violet	PA 10619 Multipack	1
 <p><b>HRT 45</b></p>	3.5	0	1,50 Schlinge/loop	violett/violet	PA 10626	2
	4	1	1,50 Schlinge/loop	violett/violet	PA 10627	2
 <p><b>HRTX 50</b></p>	4	1	0,90	violett/violet	PA 10617	2
	5	2	0,90	violett/violet	PA 10618	2
<p><b>Asymptotische schneidende Rundkörper = ART</b> Asymptotic, round bodied, trocar point = ART</p>						
 <p><b>ART 25</b></p>	1.5	4-0	0,45	violett/violet	PA 1281	1
<p><b>3/8-Kreis Rundkörper = DR, DRF</b> 3/8 circle, round bodied = DR, DRF</p>						
 <p><b>DR 10 F</b></p>	0.7	6-0	0,45	violett/violet	PA 1071	2
<p><b>3/8-Kreis schneidende Rundkörper = DRT</b> 3/8 circle, round bodied, trocar point = DRT</p>						
 <p><b>DRT 12</b></p>	0.7	6-0	0,45	violett/violet	PA 1081	2
	1	5-0	0,45	violett/violet	PA 1082	2
 <p><b>DRT 18</b></p>	1.5	4-0	0,45	ungefärbt/ undyed	PA 1083	2

Nadel / needle	Stärke Nr. gauge no.		Länge/length m	Farbe/colour	Best.-Nr. code no.	Pckg.-Inhalt box content in Dtzd./dozen
	metric	USP				
<b>3/8-Kreis Rundkörper stumpf = DRN</b> <i>3/8 circle, round bodied, blunt point = DRN</i>						
<b>○ DRN 64</b> 	3.5	0	0,90	ungefärbt/ undyed	PA 1271	2
<b>1/2-Kreis schneidende = HS, HSX mit PREMIUM-Schliff = HSM</b> <i>1/2 circle, reverse cutting = HS, HSX PREMIUM cut = HSM</i>						
<b>▽ HSM 13</b>  PREMIUM-Schliff / PREMIUM cut	1	5-0	0,45	ungefärbt/ undyed	PA 1120	2
<b>▼ HS 18</b> 	1.5	4-0	0,70	violett/violet	PA 11112	2
	2	3-0	0,70	violett/violet	PA 1113	2
	3	2-0	0,70	violett/violet	PA 1114	2
<b>▼ HS 22</b> 	2	3-0	0,70	violett/violet	PA 1117	2
	3	2-0	0,70	violett/violet	PA 1118	2
	1.5	4-0	0,70	ungefärbt/ undyed	PA 11118	2
	2	3-0	0,70	ungefärbt/ undyed	PA 1119	2
	3	2-0	0,70	ungefärbt/ undyed	PA 11110	2
<b>▼ HSX 22</b> 	3	2-0	0,70	violett/violet	PA 11117	2
<b>▼ HS 35</b> 	3	2-0	0,70	violett/violet	PA 1110	2
	3.5	0	0,70	violett/violet	PA 1111	2
	4	1	0,70	violett/violet	PA 1112	2
<b>▼ HS 40</b> 	4	1	0,90	violett/violet	PA 11113	2
	5	2	0,90	violett/violet	PA 11114	2
<b>▼ HS 50</b> 	4	1	0,70	violett/violet	PA 11116	2
	6	4	0,90	violett/violet	PA 11115	1

# PGA RESORBA® Polyglykolsäure

## Sterile Nadel-Faden-Kombination









Needle - suture - combination, sterile

Nadel / needle	Stärke Nr. gauge no.		Länge/length m	Farbe/colour	Best.-Nr. code no.	Pckg.-Inhalt box content in Dtzd./dozen
	metric	USP				
<b>3/8-Kreis schneidende = DS mit PREMIUM-Schliff = DSM</b> <i>3/8 circle, reverse cutting = DS PREMIUM cut = DSM</i>						
<b>▽ DSM 11</b>  PREMIUM-Schliff / PREMIUM cut	0.7	6-0	0,45	ungefärbt/ undyed	PA 1158	2
<b>▽ DSM 13</b>  PREMIUM-Schliff / PREMIUM cut	1 0.7 1 0.7	5-0 6-0 5-0 6-0	0,45 0,70 0,70 0,45	violett/violet violett/violet violett/violet ungefärbt/ undyed	PA 1159 PA 11512 PA 11511 PA 1150	2 2 2 2
	1	5-0	0,45	ungefärbt/ undyed	PA 1151	2
	1.5	4-0	0,45	ungefärbt/ undyed	PA 1152	2
<b>▽ 2 x DSM 13</b>  PREMIUM-Schliff / PREMIUM cut	1 1.5	5-0 4-0	0,45 0,45	violett/violet violett/violet	PA 11515 PA 11516	2 2
<b>▽ 2 x DSM 13 S</b>  PREMIUM-Schliff / PREMIUM cut	1	5-0	0,45	violett/violet	PA 11514	2
<b>▼ DS 18 F</b> 	1.5	4-0	0,45	ungefärbt/ undyed	PA 11415	2
	1.5	4-0	0,70	ungefärbt/ undyed	PA 11414	2
<b>▼ DS 18</b> 	1 1.5 2 1	5-0 4-0 3-0 5-0	0,45 0,45 0,70 0,45	violett/violet violett/violet violett/violet ungefärbt/ undyed	PA 11417 PA 11418 PA 11416 PA 1140	2 2 2 2
	1.5	4-0	0,45	ungefärbt/ undyed	PA 1141	2
	2	3-0	0,45	ungefärbt/ undyed	PA 1142	2
	2	3-0	0,70	ungefärbt/ undyed	PA 11413	2
	2	3-0	4 x 0,45	ungefärbt/ undyed	PA 11419 Multipack	1

# PGA RESORBA® Polyglykolsäure

## Sterile Nadel-Faden-Kombination









Needle - suture - combination, sterile

Nadel / needle	Stärke Nr. gauge no.		Länge/length m	Farbe/colour	Best.-Nr. code no.	Pckg.-Inhalt box content in Dtzd./dozen
	metric	USP				
 <b>DSM 18</b> PREMIUM-Schliff / PREMIUM cut	1.5	4-0	0,70	violett/violet	PA 11510	2
	1.5	4-0	0,45	ungefärbt/ undyed	PA 1154	2
	2	3-0	0,45	ungefärbt/ undyed	PA 1155	2
 <b>DSM 18 F</b> PREMIUM-Schliff / PREMIUM cut	1.5	4-0	0,45	ungefärbt/ undyed	PA 1153	2
 <b>DS 24</b>	3	2-0	0,70	violett/violet	PA 11412	2
	2	3-0	0,70	ungefärbt/ undyed	PA 1145	2
	3	2-0	0,70	ungefärbt/ undyed	PA 1146	2
 <b>DSM 24</b> PREMIUM-Schliff / PREMIUM cut	2	3-0	0,45	violett/violet	PA 11513	2
	2	3-0	0,45	ungefärbt/ undyed	PA 1156	2
	3	2-0	0,45	ungefärbt/ undyed	PA 1157	2
 <b>DS 30</b>	3.5	0	0,70	violett/violet	PA 11411	2
	3	2-0	0,70	ungefärbt/ undyed	PA 1149	2
	2	3-0	0,70	ungefärbt/ undyed	PA 11421	2
	3.5	0	0,70	ungefärbt/ undyed	PA 1148	2
 <b>DS 40</b>	3	2-0	0,70	ungefärbt/ undyed	PA 11420	2
<b>1/2-Kreis gebogen außen schneidende = KS</b> <i>1/2 curved, reverse cutting = KS</i>						
 <b>KS 20</b>	2	3-0	0,45	violett/violet	PA 1181	2
<b>Gerade schneidende = GS</b> <i>straight, cutting = GS</i>						
 <b>GS 12</b>	1.5	4-0	0,70	ungefärbt/ undyed	PA 1171	2
 <b>GS 60</b>	3	2-0	0,70	ungefärbt/ undyed	PA 1172	2

# PGA RESORBA® Polyglykolsäure

## Sterile Nadel-Faden-Kombination

Needle - suture - combination, sterile

Nadel / needle	Stärke Nr. gauge no.		Länge/length m	Farbe/colour	Best.-Nr. code no.	Pckg.-Inhalt box content in Dtzd./dozen
	metric	USP				
<b>3/8-Kreis schneidende Spatula, mit PREMIUM-Schliff = DSPM</b> <i>3/8 circle, spatulated, PREMIUM cut = DSPM</i>						
 <b>2 x DSPM 7</b>  PREMIUM-Schliff / PREMIUM cut	0.5	7-0	0,45	violett/violet	PA 1201	2
<b>1/4-Kreis schneidende Spatula, mit PREMIUM-Schliff = VSPM, VSPM F, VSPM L</b> <i>1/4 circle, spatulated, PREMIUM cut = VSPM, VSPM F, VSPM L</i>						
 <b>VSPM 6</b>  PREMIUM-Schliff / PREMIUM cut	0.7	6-0	0,45	violett/violet	PA 1214	2
 <b>2 x VSPM 8 F</b>  PREMIUM-Schliff / PREMIUM cut	0.7	6-0	0,45	violett/violet	PA 1210	2
	1	5-0	0,45	violett/violet	PA 1211	2
	0.7	6-0	0,45	ungefärbt/ undyed	PA 1212	2
	1	5-0	0,45	ungefärbt/ undyed	PA 1213	2
 <b>2 x VSPM 8 L</b>  PREMIUM-Schliff / PREMIUM cut	0.7	6-0	0,25	violett/violet	PA 1219	2
	0.7	6-0	0,45	violett/violet	PA 1215	2
	1	5-0	0,45	violett/violet	PA 1216	2
	0.7	6-0	0,45	ungefärbt/ undyed	PA 1217	2
	1	5-0	0,45	ungefärbt/ undyed	PA 1218	2



**PGA RESORBA®** Polyglykolsäure  
 Einzelfadenpackungen, steril in vorgeschnittenen Längen  
 Sterile pre-cut suture, non-neededled

Stärke Nr. gauge no. metric    USP		Länge/length m	Farbe/colour	Best.-Nr. code no.	Pckg.-Inhalt box content in Dtzd./dozen
0.7	6-0	3 x 0,45	violett/violet	PS 133	2
1	5-0	3 x 0,45	violett/violet	PS 233	2
1.5	4-0	3 x 0,45	violett/violet	PS 333	2
2	3-0	3 x 0,45	violett/violet	PS 433	2
3	2-0	3 x 0,45	violett/violet	PS 533	2
3.5	0	3 x 0,45	violett/violet	PS 633	2
4	1	3 x 0,45	violett/violet	PS 733	2
5	2	3 x 0,45	violett/violet	PS 833	2
7	5	3 x 0,45	violett/violet	PS 1033	2
1	5-0	6 x 0,45	violett/violet	PS 265	2
1.5	4-0	6 x 0,45	violett/violet	PS 365	2
2	3-0	6 x 0,45	violett/violet	PS 465	2
3	2-0	6 x 0,45	violett/violet	PS 565	2
3.5	0	6 x 0,45	violett/violet	PS 665	2
4	1	6 x 0,45	violett/violet	PS 765	2
5	2	6 x 0,45	violett/violet	PS 865	2
1.5	4-0	12 x 0,45	violett/violet	PS 3125	2
2	3-0	12 x 0,45	violett/violet	PS 4125	2
3	2-0	12 x 0,45	violett/violet	PS 5125	2
3.5	0	12 x 0,45	violett/violet	PS 6125	2
4	1	12 x 0,45	violett/violet	PS 7125	2
5	2	12 x 0,45	violett/violet	PS 8125	2
7	5	3 x 0,50	violett/violet	PS 1034	2
1	5-0	2 x 0,70	violett/violet	PS 220	2
1.5	4-0	2 x 0,70	violett/violet	PS 320	2
2	3-0	2 x 0,70	violett/violet	PS 420	2
3	2-0	2 x 0,70	violett/violet	PS 520	2
3.5	0	2 x 0,70	violett/violet	PS 620	2
4	1	2 x 0,70	violett/violet	PS 720	2
5	2	2 x 0,70	violett/violet	PS 820	2
1.5	4-0	5 x 0,70	violett/violet	PS 350	2
2	3-0	5 x 0,70	violett/violet	PS 450	2
3	2-0	5 x 0,70	violett/violet	PS 550	2
3.5	0	5 x 0,70	violett/violet	PS 650	2
4	1	5 x 0,70	violett/violet	PS 750	2
5	2	5 x 0,70	violett/violet	PS 850	2
6	4	4 x 0,90	violett/violet	PS 949	2
7	5	4 x 0,90	violett/violet	PS 1049	2
6	4	3 x 1,00	violett/violet	PS 939	1
7	5	3 x 1,00	violett/violet	PS 1039	1
1.5	4-0	1 x 1,50	violett/violet	PS 315	2
2	3-0	1 x 1,50	violett/violet	PS 415	2
3	2-0	1 x 1,50	violett/violet	PS 515	2
3.5	0	1 x 1,50	violett/violet	PS 615	2
4	1	1 x 1,50	violett/violet	PS 715	2
5	2	1 x 1,50	violett/violet	PS 815	2
6	4	1 x 1,50	violett/violet	PS 915	2
7	5	1 x 1,50	violett/violet	PS 1015	2

**PGA RESORBA®** Polyglykolsäure  
 Einzelfadenpackungen, steril in vorgeschnittenen Längen  
 Sterile pre-cut suture, non-neededled

Stärke Nr. gauge no. metric    USP		Länge/length m	Farbe/colour	Best.-Nr. code no.	Pckg.-Inhalt box content in Dtzd./dozen
1	5-0	3 x 0,45	ungefärbt/ undyed	PU 233	2
1.5	4-0	3 x 0,45	ungefärbt/ undyed	PU 333	2
2	3-0	3 x 0,45	ungefärbt/ undyed	PU 433	2
3	2-0	3 x 0,45	ungefärbt/ undyed	PU 533	2
3.5	0	3 x 0,45	ungefärbt/ undyed	PU 633	2
4	1	3 x 0,45	ungefärbt/ undyed	PU 733	2
5	2	3 x 0,45	ungefärbt/ undyed	PU 833	2
1.5	4-0	6 x 0,45	ungefärbt/ undyed	PU 365	2
2	3-0	6 x 0,45	ungefärbt/ undyed	PU 465	2
3	2-0	6 x 0,45	ungefärbt/ undyed	PU 565	2
3.5	0	6 x 0,45	ungefärbt/ undyed	PU 665	2
4	1	6 x 0,45	ungefärbt/ undyed	PU 765	2
5	2	6 x 0,45	ungefärbt/ undyed	PU 865	2
2	3-0	12 x 0,45	ungefärbt/ undyed	PU 4125	2
3	2-0	12 x 0,45	ungefärbt/ undyed	PU 5125	2
3.5	0	12 x 0,45	ungefärbt/ undyed	PU 6125	2
3	2-0	2 x 0,70	ungefärbt/ undyed	PU 520	2
3.5	0	2 x 0,70	ungefärbt/ undyed	PU 620	2
5	2	2 x 0,70	ungefärbt/ undyed	PU 820	2
2	3-0	5 x 0,70	ungefärbt/ undyed	PU 450	2
3	2-0	5 x 0,70	ungefärbt/ undyed	PU 550	2
3.5	0	5 x 0,70	ungefärbt/ undyed	PU 650	2
4	1	5 x 0,70	ungefärbt/ undyed	PU 750	2
5	2	5 x 0,70	ungefärbt/ undyed	PU 850	2

# PGA RESORBA® Polyglykolsäure

## Sterile Einzelfäden im Ligatupack (auf Handrollen)

*Sterile pre-cut suture in ligature pack*

Stärke Nr. gauge no.		Länge/length m	Farbe/colour	Best.-Nr. code no.	Pckg.-Inhalt box content in Dtzd./dozen
metric	USP				
1.5	4-0	1 x 2,50	violett/violet	PL 100	1
2	3-0	1 x 2,50	violett/violet	PL 101	1
3	2-0	1 x 2,50	violett/violet	PL 102	1
3.5	0	1 x 2,50	violett/violet	PL 103	1
4	1	1 x 2,50	violett/violet	PL 104	1
5	2	1 x 2,50	violett/violet	PL 105	1
6	4	1 x 2,50	violett/violet	PL 106	1
7	5	1 x 2,50	violett/violet	PL 107	1

## Sterile PGA-Schlingen, einzeln verpackt

*Sterile PGA-Loops, single packed*

Stärke Nr. gauge no.		Länge/length m	Farbe/colour	Best.-Nr. code no.	Pckg.-Inhalt box content
metric	USP				
3	2-0	0,60	violett/violet	PSV 5	2
3.5	0	0,60	violett/violet	PSV 6	2
4	1	0,60	violett/violet	PSV 7	2
5	2	0,60	violett/violet	PSV 8	2

# Caprolon

Caprolon ist ein synthetisches und langfristig absorbierbares Nahtmaterial aus Poly(L-Lactid-co- $\epsilon$ -Caprolacton). Die Reißfestigkeit des Materials nimmt nach ca. 8 Wochen um die Hälfte ab (Halbwertszeit), die vollständige Degradation ist nach etwa 25 Wochen abgeschlossen. Der, zur Optimierung des Gewebedurchzugs beschichtete monofile Faden, ist violett eingefärbt, für die Hautnaht aber auch ungefärbt erhältlich.

- langfristig absorbierbar, synthetisch
- sehr hohe Reißkraft
- gute Geschmeidigkeit
- belastbarer und sicherer Knotensitz
- minimale Gewebereaktion

Caprolon

# Caprolon









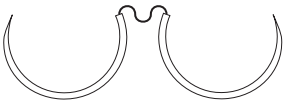

*Caprolon is a synthetic and longterm absorbable suture made from Poly(L-Lactid-co- $\epsilon$ -Caprolacton). Tensile strength of this material is reduced by one half after approximately eight weeks (half life). Absorption is complete after about 25 weeks. For optimal handling and minimal tissue trauma Caprolon is coated with Resolactone. It is available violet or undyed especially for skin closure.*

- *synthetic with a long period of action*
- *high tensile strength*
- *permanent pliability*
- *high knot security*
- *excellent biocompatibility*

# CAPROLON RESORBA® P (LA/CL)

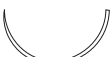
## Sterile Nadel-Faden-Kombination







Needle - suture - combination, sterile

Nadel / needle	Stärke/gauge		Länge/length m	Farbe/colour	Best.-Nr. code no.	Pckg.-Inhalt box content in Dtzd./dozen
	metric	USP				
<b>5/8-Kreis Rundkörper = FR</b> 5/8 circle, round bodied = FR						
● 2 x FR 27 	3	2-0	0,70	violett/violet	PM 2011	2
<b>1/2-Kreis Rundkörper = HR, HRS</b> 1/2 circle, round bodied = HR, HRS						
● HR 12 	0.7	6-0	0,70	violett/violet	PM 2021	2
	1	5-0	0,70	violett/violet	PM 2022	2
	1.5	4-0	0,70	violett/violet	PM 2023	2
● 2 x HR 12 	1	5-0	0,70	violett/violet	PM 2024	2
	1.5	4-0	0,70	violett/violet	PM 20222	2
● HRS 12 	2	3-0	0,70	violett/violet	PM 2031	2
	3	2-0	0,70	violett/violet	PM 2032	2
	3.5	0	0,70	violett/violet	PM 2033	2
● HR 17 	0.7	6-0	0,70	violett/violet	PM 2025	2
	1	5-0	0,70	violett/violet	PM 2026	2
	1.5	4-0	0,70	violett/violet	PM 2027	2
	2	3-0	0,70	violett/violet	PM 2028	2
● 2 x HR 17 	1	5-0	0,70	violett/violet	PM 2029	2
	1.5	4-0	0,70	violett/violet	PM 20210	2
● HR 22 	1.5	4-0	0,70	violett/violet	PM 20211	2
	2	3-0	0,70	violett/violet	PM 20212	2
● HRS 22 	3	2-0	0,70	violett/violet	PM 2034	2
	3.5	0	0,70	violett/violet	PM 2035	2
● HR 27 	1.5	4-0	0,70	violett/violet	PM 20213	2
	2	3-0	0,70	violett/violet	PM 20214	2
	3	2-0	0,70	violett/violet	PM 20215	2
	2	3-0	6 x 0,70	violett/violet	PM 20216	1
					Multipack	
● 2 x HR 27 	1.5	4-0	0,70	violett/violet	PM 20217	2
	2	3-0	0,70	violett/violet	PM 20218	2
	3	2-0	0,70	violett/violet	PM 20219	2

# CAPROLON RESORBA® P (LA/CL)

Sterile Nadel-Faden-Kombination

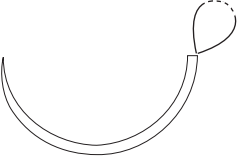

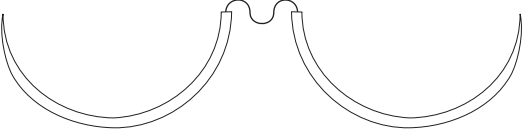
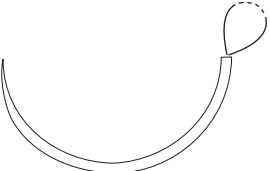





Needle - suture - combination, sterile

Nadel / needle	Stärke/gauge		Länge/length m	Farbe/colour	Best.-Nr. code no.	Pckg.-Inhalt box content in Dtzd./dozen
	metric	USP				
● HRS 27 	3	2-0	0,70	violett/violet	PM 2036	2
	3.5	0	0,70	violett/violet	PM 2037	2
	4	1	0,70	violett/violet	PM 2038	2
● HR 35 	2	3-0	0,70	violett/violet	PM 20220	2
	3	2-0	0,70	violett/violet	PM 20221	2
● HRS 35 	3	2-0	0,70	violett/violet	PM 2039	2
	3.5	0	0,70	violett/violet	PM 20310	2
	4	1	0,70	violett/violet	PM 20311	2
● HRS 40 	3	2-0	0,90	violett/violet	PM 20312	2
	3.5	0	0,90	violett/violet	PM 20313	2
	4	1	0,90	violett/violet	PM 20314	2
● HRS 40 / Schlinge / loop 	3.5	0	1,50	violett/violet	PM 20318	2
	4	1	1,50	violett/violet	PM 20319	2
● HRS 48 	3.5	0	0,90	violett/violet	PM 20315	2
	4	1	0,90	violett/violet	PM 20316	2
	5	2	0,90	violett/violet	PM 20317	2
● 2 x HRS 48 	4	1	0,90	violett/violet	PM 20321	2
● HRS 48 / Schlinge / loop 	4	1	1,80	violett/violet	PM 20320	2

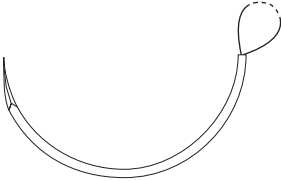
# CAPROLON RESORBA® P (LA/CL)

Sterile Nadel-Faden-Kombination

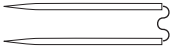





Needle - suture - combination, sterile

Nadel / needle	Stärke/gauge		Länge/length m	Farbe/colour	Best.-Nr. code no.	Pckg.-Inhalt box content in Dtzd./dozen
	metric	USP				
<b>1/2-Kreis schneidende Rundkörper = HRT</b> <i>1/2-circle round bodied, trocar point = HRT</i>						
 <b>HRT 18</b>	1	5-0	0,70	violett/violet	PM 2061	2
	1.5	4-0	0,70	violett/violet	PM 2062	2
	2	3-0	0,70	violett/violet	PM 2063	2
	3	2-0	0,70	violett/violet	PM 2064	2
 <b>HRT 22</b>	1.5	4-0	0,70	violett/violet	PM 2065	2
	2	3-0	0,70	violett/violet	PM 2066	2
 <b>HRT 25</b>	1.5	4-0	0,70	violett/violet	PM 2069	2
	2	3-0	0,70	violett/violet	PM 2067	2
	3	2-0	0,70	violett/violet	PM 2068	2
 <b>HRT 50 / Schlinge / loop</b>	4	1	1,80	violett/violet	PM 20610	2
<b>3/8-Kreis Rundkörper = DR</b> <i>3/8 circle, round bodied = DR</i>						
 <b>2 x DR 10</b>	0.5	7-0	0,70	violett/violet	PM 2071	2
	0.7	6-0	0,70	violett/violet	PM 2072	2
 <b>DR 12</b>	0.7	6-0	0,70	violett/violet	PM 2073	2
	1	5-0	0,70	violett/violet	PM 2074	2
 <b>2 x DR 12</b>	0.7	6-0	0,70	violett/violet	PM 2075	2
	1	5-0	0,70	violett/violet	PM 2076	2
<b>Gerade Rundkörper = GR</b> <i>straight, round bodied = GR</i>						
 <b>2 x GR 20</b>	1.5	4-0	0,35	violett/violet	PM 2091	2
 <b>2 x GR 65</b>	3.5	0	0,70	violett/violet	PM 2092	2
	4	1	0,70	violett/violet	PM 2093	2

# CAPROLON RESORBA® P (LA/CL)

Sterile Nadel-Faden-Kombination

Needle - suture - combination, sterile







Nadel / needle	Stärke/gauge		Länge/length m	Farbe/colour	Best.-Nr. code no.	Pckg.-Inhalt box content in Dtzd./dozen
	metric	USP				
<b>1/2-Kreis schneidende = HS</b> <i>1/2 circle, reverse cutting = HS</i>						
▼ HS 27 	3	2-0	0,70	violett/violet	PM 2111	2
	3.5	0	0,70	violett/violet	PM 2112	2
	4	1	0,70	violett/violet	PM 2113	2
▼ HS 35 	3.5	0	0,70	violett/violet	PM 2114	2
	4	1	0,70	violett/violet	PM 2115	2
▼ HS 40 	3.5	0	0,90	violett/violet	PM 2116	2
<b>3/8-Kreis schneidende = DS, mit PREMIUM-Schliff = DSM</b> <i>3/8 circle, reverse cutting = DS, PREMIUM cut = DSM</i>						
▼ DSM 11  PREMIUM-Schliff / PREMIUM cut	0.7	6-0	0,45	violett/violet	PM 2151	2
	0.7	6-0	0,45	ungefärbt/ undyed	PM 2152	2
	1	5-0	0,45	ungefärbt/ undyed	PM 2153	2
▽ DSM 13  PREMIUM-Schliff / PREMIUM cut	1	5-0	0,45	violett/violet	PM 2154	2
	1.5	4-0	0,45	violett/violet	PM 2155	2
	1	5-0	0,45	ungefärbt/ undyed	PM 2156	2
	1.5	4-0	0,45	ungefärbt/ undyed	PM 2157	2
▽ DS 18 	1	5-0	0,45	ungefärbt/ undyed	PM 2146	2
	1.5	4-0	0,45	ungefärbt/ undyed	PM 2141	2
	2	3-0	0,45	ungefärbt/ undyed	PM 2142	2
▽ DSM 18  PREMIUM-Schliff / PREMIUM cut	1.5	4-0	0,45	violett/violet	PM 21510	2
	2	3-0	0,45	violett/violet	PM 21511	2
	1.5	4-0	0,45	ungefärbt/ undyed	PM 21512	2
	2	3-0	0,45	ungefärbt/ undyed	PM 21513	2



# CAPROLON RESORBA® P (LA/CL)

Sterile Nadel-Faden-Kombination

Needle - suture - combination, sterile

Nadel / needle	Stärke/gauge		Länge/length m	Farbe/colour	Best.-Nr. code no.	Pckg.-Inhalt box content in Dtzd./dozen
	metric	USP				
▽ <b>DSM 18 F</b>  PREMIUM-Schliff / PREMIUM cut	1.5	4-0	0,45	violett/violet	PM 2158	2
	1.5	4-0	0,45	ungefärbt/ undyed	PM 2159	2
▼ <b>DS 24</b> 	1.5	4-0	0,45	ungefärbt/ undyed	PM 2143	2
	2	3-0	0,45	ungefärbt/ undyed	PM 2144	2
	3	2-0	0,45	ungefärbt/ undyed	PM 2145	2
▽ <b>DSM 24</b>  PREMIUM-Schliff / PREMIUM cut	1.5	4-0	0,45	ungefärbt/ undyed	PM 21514	2
	2	3-0	0,45	ungefärbt/ undyed	PM 21515	2
	3	2-0	0,45	ungefärbt/ undyed	PM 21516	2
<p><b>3/8-Kreis schneidende Rundkörper (Diamond-Spitze), mit PREMIUM-Schliff = DRTM</b>  <i>3/8 circle, round bodied, trocar point, PREMIUM cut = DRTM</i></p>						
⊙ <b>DRTM 10</b>  PREMIUM-Schliff / PREMIUM cut	0.5	7-0	0,70	violett/violet	PM 2251	2
	0.7	6-0	0,70	violett/violet	PM 2252	2
⊙ <b>2 x DRTM 10</b>  PREMIUM-Schliff / PREMIUM cut	0.5	7-0	0,70	violett/violet	PM 2253	2
	0.7	6-0	0,70	violett/violet	PM 2254	2
⊙ <b>DRTM 12</b>  PREMIUM-Schliff / PREMIUM cut	0.7	6-0	0,70	violett/violet	PM 2255	2
	1	5-0	0,70	violett/violet	PM 2256	2
⊙ <b>2 x DRTM 12</b>  PREMIUM-Schliff / PREMIUM cut	0.7	6-0	0,70	violett/violet	PM 2257	2
	1	5-0	0,70	violett/violet	PM 2258	2

# Mopylen

Mopylen®, ein nichtabsorbierbares blaues Monofilament aus Polypropylen, ist besonders für dauerimplantierte Nähte, z. B. bei Eingriffen in der Herz- und Gefäßchirurgie geeignet. Durch die hydrophobe Eigenschaft kommt es bei Mopylen® nicht zu einer Quellung des Monofilaments im Gewebe. Dieser Vorteil erleichtert den Fadenzug und die Wundheilung erheblich und macht Mopylen® auch für die Hautnaht interessant.

Mopylen

- nichtabsorbierbarer Polypropylenfaden
- dauerhaft hohe Reißfestigkeit
- hydrophob
- nicht-thrombogen
- geringste Gewebereaktion

# Mopylen











*Mopylen®, a blue non-absorbable monofilament of polypropylene, is especially suitable for long-term implantations as used in cardiac and vascular surgery. Due to its hydrophobic character, the monofilament does not expand in tissue. This advantage greatly facilitates passage through tissue as well as woundhealing. Therefore, Mopylen® has gained wide acceptance for skin closure as well.*

- non-absorbable suture
- high and permanent tensile strength
- water-repellent
- antithrombotic
- almost non-irritating

# Mopylen® Polypropylen

## Sterile Nadel-Faden-Kombination









Needle - suture - combination, sterile

Nadel / needle	Stärke Nr. gauge no.		Länge/length m	Farbe/colour	Best.-Nr. code no.	Pckg.-Inhalt box content in Dtzd./dozen
	metric	USP				
<b>1/2-Kreis Rundkörper = HR,HRS</b> 1/2 circle, round bodied = HR, HRS						
● HR 6 	0.5	7-0	0,30	blau/blue	70233	2
	0.7	6-0	0,30	blau/blue	70234	2
● 2 x HR 6 	0.5	7-0	0,45	blau/blue	70235	2
	0.7	6-0	0,45	blau/blue	70236	2
● HR 8 	0.5	7-0	0,30	blau/blue	70223	2
	0.7	6-0	0,30	blau/blue	70224	2
● 2 x HR 8 	0.5	7-0	0,45	blau/blue	70225	2
	0.7	6-0	0,45	blau/blue	70226	2
● HR 10 	0.7	6-0	0,45	blau/blue	70230	3
● 2 x HR 10 	0.7	6-0	0,75	blau/blue	70231	3
● HR 12 	1	5-0	0,75	blau/blue	70232	3
● 2 x HR 12 	0.7	6-0	0,75	blau/blue	7022	3
	1	5-0	0,75	blau/blue	7023	3
	1.5	4-0	0,90	blau/blue	7024	3
● 2 x HR 15 	0.7	6-0	0,75	blau/blue	7025	3
	1	5-0	0,75	blau/blue	7026	3
	0.7	6-0	4 x 0,75	blau/blue	L 70237	1
	1	5-0	4 x 0,75	blau/blue	Multi-L-Pack L 70238	1
					Multi-L-Pack	
● HR 17 	1	5-0	0,75	blau/blue	7027	3
	1.5	4-0	0,75	blau/blue	7028	3
	2	3-0	0,75	blau/blue	7029	3
● 2 x HR 17 	1	5-0	0,90	blau/blue	70210	3
	1.5	4-0	0,90	blau/blue	70211	3
	2	3-0	0,90	blau/blue	70212	3

# Mopylen® Polypropylen

## Sterile Nadel-Faden-Kombination













Needle - suture - combination, sterile

Nadel / needle	Stärke Nr. gauge no.		Länge/length m	Farbe/colour	Best.-Nr. code no.	Pckg.-Inhalt box content in Dtzd./dozen
	metric	USP				
● HR 22 	1.5	4-0	0,75	blau/blue	70213	3
	2	3-0	0,75	blau/blue	70214	3
● 2 HR 22 	1.5	4-0	0,90	blau/blue	70215	3
	2	3-0	0,90	blau/blue	70216	3
● HR 27 	2	3-0	0,75	blau/blue	70217	3
	3	2-0	0,75	blau/blue	70218	3
	3.5	0	0,75	blau/blue	70219	3
● 2 x HR 27 	1.5	4-0	0,90	blau/blue	70220	3
	2	3-0	0,90	blau/blue	70221	3
	3	2-0	0,90	blau/blue	70222	3
	1.5	4-0	1,20	blau/blue	70239	3
	2	3-0	1,20	blau/blue	70240	3
● HRS 27 	3	2-0	0,75	blau/blue	7031	3
	3.5	0	0,75	blau/blue	7032	3
● HRS 35 	3	2-0	0,75	blau/blue	7033	3
	3.5	0	0,75	blau/blue	7034	3
	4	1	0,75	blau/blue	7035	3
<b>1/2-Kreis schneidende Rundkörper = HRT</b> <i>1/2 circle trocar point, round bodied, = HRT</i>						
▼ HRT 18 	1	5-0	0,75	blau/blue	7061	3
	1.5	4-0	0,75	blau/blue	7062	3
	2	3-0	0,75	blau/blue	7063	3
▼ 2 x HRT 18 	1	5-0	0,90	blau/blue	70612	3
	1.5	4-0	0,90	blau/blue	7064	3
	2	3-0	0,90	blau/blue	7065	3
	3	2-0	0,90	blau/blue	7066	3
▼ HRT 22 	1.5	4-0	0,75	blau/blue	70613	3
	2	3-0	0,75	blau/blue	70614	3
	3	2-0	0,75	blau/blue	70615	3

# Mopylen® Polypropylen

## Sterile Nadel-Faden-Kombination











Needle - suture - combination, sterile

Nadel / needle	Stärke Nr. gauge no.		Länge/length m	Farbe/colour	Best.-Nr. code no.	Pckg.-Inhalt box content in Dtzd./dozen
	metric	USP				
<b>▼ 2 x HRT 22</b> 	1.5	4-0	0,90	blau/blue	70616	3
<b>▼ HRT 25</b> 	2	3-0	0,75	blau/blue	7068	3
	3	2-0	0,75	blau/blue	7069	3
<b>▼ 2 x HRT 25</b> 	2	3-0	0,90	blau/blue	70610	3
	3	2-0	0,90	blau/blue	70611	3
<div style="background-color: #cccccc; padding: 5px;"> <b>3/8-Kreis Rundkörper = DR, DR F</b>  <i>3/8 circle, round bodied = DR, DR F</i> </div>						
<b>● DR 5 F</b> 	0.2	10-0	0,15	blau/blue	70726	2
<b>● DR 6</b> 	0.3	9-0	0,15	blau/blue	7072	2
<b>● 2 x DR 6</b> 	0.4	8-0	0,45	blau/blue	7073	2
<b>● 2 x DR 10</b> 	0.7	6-0	4 x 0,75	blau/blue	L 70728 Multi-L-Pack	1
<b>● DR 10 F</b> 	0.5	7-0	0,75	blau/blue	7074	3
	0.7	6-0	0,75	blau/blue	70725	3
<b>● 2 x DR 10 F</b> 	0.5	7-0	0,75	blau/blue	7076	3
	0.7	6-0	0,75	blau/blue	7077	3
	0.5	7-0	4 x 0,75	blau/blue	L 70727 Multi-L-Pack	1
<b>● DR 12</b> 	1	5-0	0,75	blau/blue	7079	3
	1.5	4-0	0,75	blau/blue	70710	3
<b>● 2 x DR 12</b> 	1	5-0	0,75	blau/blue	70712	3
	1.5	4-0	0,75	blau/blue	70713	3
	1	5-0	0,90	blau/blue	70714	3
	1	5-0	4 x 0,90	blau/blue	L 70731 Multi-L-Pack	1
<b>● DR 12 F</b> 	0.7	6-0	0,75	blau/blue	7078	3



# Mopylen® Polypropylen

## Sterile Nadel-Faden-Kombination

Needle - suture - combination, sterile

Nadel / needle	Stärke Nr. gauge no.		Länge/length m	Farbe/colour	Best.-Nr. code no.	Pckg.-Inhalt box content in Dtzd./dozen
	metric	USP				
● 2 x DR 12 F 	0.7	6-0	0,75	blau/blue	70711	3
	0.7	6-0	4 x 0,75	blau/blue	L 70730 Multi-L-Pack	1
● DR 18 	1	5-0	0,75	blau/blue	70715	3
	1.5	4-0	0,75	blau/blue	70716	3
	2	3-0	0,75	blau/blue	70719	3
● 2 x DR 18 	1	5-0	0,90	blau/blue	70717	3
	1.5	4-0	0,90	blau/blue	70718	3
	2	3-0	0,90	blau/blue	70720	3
<p><b>3/8-Kreis schneidende Rundkörper = DRT mit PREMIUM-Schliff = DRTM</b>  <i>3/8 circle, trocar point, round bodied = DRT            PREMIUM cut = DRTM</i></p>						
◉ DRTM 10  PREMIUM-Schliff / PREMIUM cut	0.5	7-0	0,75	blau/blue	7251	2
	0.7	6-0	0,75	blau/blue	7252	2
◉ 2 x DRTM 10  PREMIUM-Schliff / PREMIUM cut	0.5	7-0	0,75	blau/blue	7253	2
	0.7	6-0	0,75	blau/blue	7256	2
◉ DRT 12 	0.7	6-0	0,75	blau/blue	7081	3
	1	5-0	0,75	blau/blue	7082	3
◉ 2 x DRT 12 	0.7	6-0	0,75	blau/blue	7083	3
	1	5-0	0,75	blau/blue	7084	3
◉ DRTM 12  PREMIUM-Schliff / PREMIUM cut	0.7	6-0	0,75	blau/blue	7258	2
◉ 2 x DRTM 12  PREMIUM-Schliff / PREMIUM cut	0.7	6-0	0,45	blau/blue	72511	2
	0.7	6-0	0,75	blau/blue	72510	2
	1	5-0	0,75	blau/blue	72512	2
	1	5-0	0,90	blau/blue	7259	2
◉ DRT 18 	1	5-0	0,75	blau/blue	7088	3
	1.5	4-0	0,75	blau/blue	7089	3
	2	3-0	0,75	blau/blue	70810	3

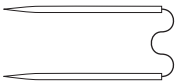
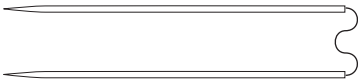
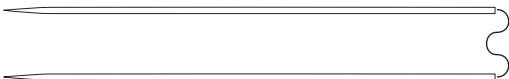
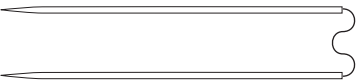

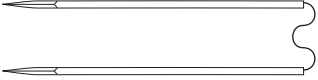



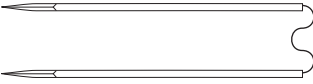

**Mopylen®** Polypropylen  
**Sterile Nadel-Faden-Kombination**  
*Needle - suture - combination, sterile*

Nadel / needle	Stärke Nr. gauge no.		Länge/length m	Farbe/colour	Best.-Nr. code no.	Pckg.-Inhalt box content in Dtzd./dozen
	metric	USP				
<b>Gerade Rundkörper = GR</b> <i>Straight round bodied = GR</i>						
<p>● 2 x GR 20</p> 	1.5	4-0	0,35	blau/blue	7091	3
<p>● 2 x GR 45</p> 	2	3-0	0,35	blau/blue	7092	3
<p>● 2 x GR 65</p> 	3	2-0	0,75	blau/blue	7094	3
<b>Sehnenauszieh-Naht nach BUNNEL</b> <i>BUNNEL's Tendon Suture</i>						
<p>● 2 x GR 45</p> 	2	3-0	0,35	blau/blue	BU 7093	1
<p>▼ DS 27</p> 			Schlinge loop	0,20		
Zubehör: Je 2 Silikon-Gummi-, Polyesterscheiben (1 Loch und 2 Loch) und Aluplomben <i>Incl. 4 buttons</i>						
<b>Gerade schneidende Rundkörper = GRT</b> <i>Straight, trocar point, round bodied = GRT</i>						
<p>▼ 2 x GRT 40</p> 	1.5	4-0	0,35	blau/blue	7102	3

# Mopylen® Polypropylen

## Sterile Nadel-Faden-Kombination

Needle - suture - combination, sterile









Nadel / needle	Stärke Nr. gauge no. metric USP		Länge/length m	Farbe/colour	Best.-Nr. code no.	Pckg.-Inhalt box content in Dtzd./dozen
<b>Sehnenauszieh-Naht nach BUNNEL</b> <i>BUNNEL's Tendon Suture</i>						
<b>▼ 2 x GRT 40</b> 	1.5	4-0	0,35	blau/blue	BU 7104	1
<b>▼ DS 24</b> 		Schlinge loop	0,20			
Zubehör: Je 2 Silikon-Gummi-, Polyesterscheiben (1 Loch und 2 Loch) und Aluplomben <i>Incl. 4 buttons</i>						
<b>1/2-Kreis schneidende = HS, mit PREMIUM-Schliff = HSM</b> <i>1/2 circle, reverse cutting = HS, PREMIUM cut = HSM</i>						
<b>▽ HSM 17</b>  PREMIUM-Schliff / PREMIUM cut	1.5	4-0	0,45	blau/blue	7126	3
<b>▼ HS 18</b> 	2	3-0	0,45	blau/blue	7111	3
<b>▼ HS 27</b> 	3 3.5	2-0 0	0,75 0,75	blau/blue blau/blue	7112 7113	3 3
<b>3/8-Kreis schneidende = DS, DS F, mit PREMIUM-Schliff = DSM, DSM F, DSMF, DSMFX</b> <i>3/8 circle, trocar point = DS, DS F, PREMIUM cut = DSM, DSM F, DSMF, DSMFX</i>						
<b>▽ DSM 7</b>  PREMIUM-Schliff / PREMIUM cut	0.5 0.7	7-0 6-0	0,45 0,45	blau/blue blau/blue	7151 71525	3 3
<b>▽ DSM 11</b>  PREMIUM-Schliff / PREMIUM cut	0.5 0.7 1	7-0 6-0 5-0	0,45 0,45 0,45	blau/blue blau/blue blau/blue	71526 7152 7153	3 3 3
<b>▽ DSMF 11</b>  PREMIUM-Schliff / PREMIUM cut	0.7	6-0	0,45	blau/blue	7221	3



# Mopylen® Polypropylen

## Sterile Nadel-Faden-Kombination







Needle - suture - combination, sterile

Nadel / needle	Stärke Nr. gauge no.		Länge/length m	Farbe/colour	Best.-Nr. code no.	Pckg.-Inhalt box content in Dtzd./dozen
	metric	USP				
▼ DS 13 	1	5-0	0,45	blau/blue	7141	3
	1.5	4-0	0,45	blau/blue	7142	3
▽ DSM 13  PREMIUM-Schliff / PREMIUM cut	0.7	6-0	0,45	blau/blue	7155	3
	1	5-0	0,45	blau/blue	7156	3
	1.5	4-0	0,45	blau/blue	7157	3
▽ DSMF 13  PREMIUM-Schliff "fein" / PREMIUM cut "fine"	0.7	6-0	0,45	blau/blue	7222	3
	1	5-0	0,45	blau/blue	7223	3
	1.5	4-0	0,45	blau/blue	72215	3
▽ DSMFX 13  PREMIUM-Schliff Spitze "fein" / PREMIUM cut point "fine"	1	5-0	0,45	blau/blue	72219	3
▼ DS 16 	1	5-0	0,45	blau/blue	7145	3
	1.5	4-0	0,45	blau/blue	71446	3
	1.5	4-0	0,60	blau/blue	71435	2
mit Intrakutanzubehör <i>Intracutaneous suture</i>						
▽ DSM 16  PREMIUM-Schliff / PREMIUM cut	0.7	6-0	0,45	blau/blue	71530	3
	1	5-0	0,45	blau/blue	71510	3
	1.5	4-0	0,45	blau/blue	71511	3
	1.5	4-0	0,60	blau/blue	71532	2
mit Intrakutanzubehör <i>Intracutaneous suture</i>						
▽ DSMF 16  PREMIUM-Schliff "fein" / PREMIUM cut "fine"	1	5-0	0,45	blau/blue	7229	3
	1.5	4-0	0,45	blau/blue	72210	3
▼ DS 18 	1	5-0	0,45	blau/blue	7147	3
	1.5	4-0	0,45	blau/blue	7148	3
	2	3-0	0,45	blau/blue	7149	3
	1.5	4-0	0,75	blau/blue	71410	3
	2	3-0	0,75	blau/blue	71411	3
	1.5	4-0	0,60	blau/blue	71439	2
	mit Intrakutanzubehör <i>Intracutaneous suture</i>					
2	3-0	0,60	blau/blue	71440	2	
mit Intrakutanzubehör <i>Intracutaneous suture</i>						
▼ DS 18 F 	1.5	4-0	0,75	blau/blue	71436	3
	1.5	4-0	0,75	blau/blue	71437	3

# Mopylen® Polypropylen

## Sterile Nadel-Faden-Kombination







Needle - suture - combination, sterile

Nadel / needle	Stärke Nr. gauge no.		Länge/length m	Farbe/colour	Best.-Nr. code no.	Pckg.-Inhalt box content in Dtzd./dozen
	metric	USP				
▼ <b>DSM 18</b>  PREMIUM-Schliff / PREMIUM cut	1	5-0	0,45	blau/blue	71512	3
	1.5	4-0	0,45	blau/blue	71513	3
	2	3-0	0,45	blau/blue	71514	3
	3	2-0	0,45	blau/blue	71515	3
	1.5	4-0	0,75	blau/blue	71516	3
	2	3-0	0,75	blau/blue	71517	3
	3	2-0	0,75	blau/blue	71518	3
	1.5	4-0	0,60	blau/blue	71533	2
					mit Intrakutanzubehör Intracutaneous suture	
	2	3-0	0,60	blau/blue	71534	2
				mit Intrakutanzubehör Intracutaneous suture		
▼ <b>DSM 18 F</b>  PREMIUM-Schliff / PREMIUM cut	1.5	4-0	0,45	blau/blue	71550	3
	1.5	4-0	0,75	blau/blue	71551	3
▼ <b>DSMF 18</b>  PREMIUM-Schliff "fein" / PREMIUM cut "fine"	1	5-0	0,45	blau/blue	7225	3
	1.5	4-0	0,45	blau/blue	7226	3
	2	3-0	0,45	blau/blue	7227	3
	1.5	4-0	0,75	blau/blue	72216	3
	2	3-0	0,75	blau/blue	72217	3
▼ <b>DSMFX 18</b>  PREMIUM-Schliff Spitze "fein" / PREMIUM cut point "fine"	1.5	4-0	0,45	blau/blue	72220	3
▼ <b>DS 21</b> 	1.5	4-0	0,45	blau/blue	71427	3
	2	3-0	0,45	blau/blue	71428	3
	3	2-0	0,45	blau/blue	71429	3
	1.5	4-0	0,75	blau/blue	71430	3
	2	3-0	0,75	blau/blue	71431	3
	3	2-0	0,75	blau/blue	71432	3
▼ <b>DSM 21</b>  PREMIUM-Schliff / PREMIUM cut	1.5	4-0	0,45	blau/blue	71536	3
	2	3-0	0,45	blau/blue	71537	3
	3	2-0	0,45	blau/blue	71538	3
	1.5	4-0	0,75	blau/blue	71539	3
	2	3-0	0,75	blau/blue	71540	3
	3	2-0	0,75	blau/blue	71541	3

# Mopylen® Polypropylen

## Sterile Nadel-Faden-Kombination







Needle - suture - combination, sterile

Nadel / needle	Stärke Nr.		Länge/length m	Farbe/colour	Best.-Nr. code no.	Pckg.-Inhalt box content in Dtzd./dozen
	gauge no. metric	USP				
<b>▼ DS 24</b> 	1.5	4-0	0,45	blau/blue	71414	3
	2	3-0	0,45	blau/blue	71415	3
	3	2-0	0,45	blau/blue	71425	3
	2	3-0	0,75	blau/blue	71416	3
	3	2-0	0,75	blau/blue	71426	3
	2	3-0	0,60	blau/blue	71442	2
	3	2-0	0,60	blau/blue	71443	2
				mit Intrakutanzubehör <i>Intracutaneous suture</i>		
				mit Intrakutanzubehör <i>Intracutaneous suture</i>		
<b>▽ DSM 24</b>  PREMIUM-Schliff / <i>PREMIUM cut</i>	1.5	4-0	0,45	blau/blue	71520	3
	2	3-0	0,45	blau/blue	71521	3
	3	2-0	0,45	blau/blue	71522	3
	1.5	4-0	0,75	blau/blue	71531	3
	2	3-0	0,75	blau/blue	71523	3
	3	2-0	0,75	blau/blue	71524	3
	2	3-0	0,60	blau/blue	71535	2
				mit Intrakutanzubehör <i>Intracutaneous suture</i>		
				mit Intrakutanzubehör <i>Intracutaneous suture</i>		
<b>▽ DSMF 24</b>  PREMIUM-Schliff "fein" / <i>PREMIUM cut "fine"</i>	1.5	4-0	0,45	blau/blue	72211	3
	2	3-0	0,45	blau/blue	72212	3
	3	2-0	0,45	blau/blue	72213	3
	2	3-0	0,75	blau/blue	72218	3
<b>▽ DSMFX 24</b>  PREMIUM-Schliff Spitze "fein" / <i>PREMIUM cut point "fine"</i>	2	3-0	0,45	blau/blue	72221	3
<b>▼ DS 27</b> 	3	2-0	0,45	blau/blue	71418	3
	3	2-0	0,75	blau/blue	71433	3
<b>▽ DSM 27</b>  PREMIUM-Schliff / <i>PREMIUM cut</i>	3	2-0	0,45	blau/blue	71542	3
	3	2-0	0,75	blau/blue	71543	3
<b>▼ DS 30</b> 	3	2-0	0,45	blau/blue	71421	3
	3.5	0	0,45	blau/blue	71422	3
	1.5	4-0	0,75	blau/blue	71419	3
	2	3-0	0,75	blau/blue	71420	3
	3	2-0	0,75	blau/blue	71424	3

# Mopylen® Polypropylen

## Sterile Nadel-Faden-Kombination

Needle - suture - combination, sterile

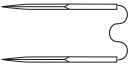
Nadel / needle	Stärke Nr. gauge no.		Länge/length m	Farbe/colour	Best.-Nr. code no.	Pckg.-Inhalt box content in Dtzd./dozen
	metric	USP				
▼ <b>DSM 30</b>  PREMIUM-Schliff / PREMIUM cut	2	3-0	0,75	blau/blue	71544	3
	3	2-0	0,75	blau/blue	71546	3
	3.5	0	0,45	blau/blue	71547	3
▼ <b>DSMFX 30</b>  PREMIUM-Schliff Spitze "fein" / PREMIUM cut point "fine"	2	3-0	0,75	blau/blue	72222	3
	3	2-0	0,75	blau/blue	72223	3
▼ <b>DS 40</b> 	3	2-0	0,75	blau/blue	71434	3
	3.5	0	0,75	blau/blue	71423	3
▼ <b>DSM 40</b>  PREMIUM-Schliff / PREMIUM cut	3.5	0	0,75	blau/blue	71549	3
<b>1/2-Kreis gebogen außen schneidende = KS</b> <i>1/2 circle, curved, reverse cutting = KS</i>						
▼ <b>KS 20</b> 	2	3-0	0,45	blau/blue	7181	3
<b>Gerade schneidende = GS</b> <i>Straight, cutting = GS</i>						
▼ <b>GS 12</b> 	1.5	4-0	0,45	blau/blue	7171	3
▼ <b>GS 60</b> 	2	3-0	0,75	blau/blue	7172	3
<b>Gerade Spatula, PREMIUM-Schliff = GSPM</b> <i>Straight, spatulated, PREMIUM cut = GSPM</i>						
▼ <b>2 x GSPM 16</b>  PREMIUM-Schliff / PREMIUM cut	0.2	10-0	0,20	blau/blue	7261	2

## Resopren

Resopren® ist ein monofiler, nichtabsorbierbarer Faden aus Polyvinylidendifluorid (PVDF). Aufgrund der hohen Alterungsbeständigkeit und dem guten Knotensitz ist Resopren® besonders für Langzeitimplantationen geeignet. Durch die hydrophobe Eigenschaft kommt es bei Resopren® nicht zu einer Quellung des Monofilaments im Gewebe. Dieser Vorteil erleichtert den Fadenzug und die Wundheilung erheblich und macht Resopren® auch für die Hautnaht interessant.

- nichtabsorbierbarer PVDF-Faden
- chemisch inert
- hydrophob
- extrem alterungsbeständig
- keinerlei Gewebereaktion

Resopren

## Resopren











*Resopren® is a monofilament non-absorbable suture of polyvinylidenedifluoride (PVDF). With regard to its permanence and high knot security, Resopren® is especially suitable for long-term implantations. Due to the hydrophobic character, the monofilament does not expand in tissue. This advantage greatly facilitates passage through tissue and wound-healing, and is therefore also interesting for skin closure.*

- *non-absorbable suture*
- *high and permanent tensile strength*
- *absolutely inert*
- *water-repellent*
- *non-irritating*

# Resopren® PVDF-Faden

## Sterile Nadel-Faden-Kombination











Needle - suture - combination, sterile

Nadel / needle	Stärke Nr. gauge no.		Länge/length m	Farbe/colour	Best.-Nr. code no.	Pckg.-Inhalt box content in Dtzd./dozen
	metric	USP				
<b>1/2-Kreis Rundkörper = HR, HRS</b> <i>1/2 circle, round bodied = HR, HRS</i>						
● HR 10 	0.7	6-0	0,45	blau/blue	77021	3
● 2 x HR 10 	0.7	6-0	0,75	blau/blue	77022	3
● 2 x HR 12 	0.7	6-0	0,75	blau/blue	77023	3
	1	5-0	0,75	blau/blue	77024	3
	1.5	4-0	0,90	blau/blue	77025	3
● 2 x HR 15 	0.7	6-0	0,75	blau/blue	77026	3
	1	5-0	0,75	blau/blue	77027	3
	0.7	6-0	4 x 0,75	blau/blue	L 77028	1
	1	5-0	4 x 0,75	blau/blue	Multi-L-Pack	1
					L 77029	
● HR 17 	1	5-0	0,75	blau/blue	770210	3
	1.5	4-0	0,75	blau/blue	770211	3
	2	3-0	0,75	blau/blue	770212	3
● 2 x HR 17 	1	5-0	0,90	blau/blue	770213	3
	1.5	4-0	0,90	blau/blue	770214	3
	2	3-0	0,90	blau/blue	770215	3
● HR 22 	1.5	4-0	0,75	blau/blue	770216	3
	2	3-0	0,75	blau/blue	770217	3
● 2 x HR 22 	1.5	4-0	0,90	blau/blue	770218	3
	2	3-0	0,90	blau/blue	770219	3
● HR 27 	2	3-0	0,75	blau/blue	770220	3
	3	2-0	0,75	blau/blue	770221	3
● 2 x HR 27 	1.5	4-0	0,90	blau/blue	770222	3
	2	3-0	0,90	blau/blue	770223	3
	3	2-0	0,90	blau/blue	770224	3

# Resopren® PVDF-Faden

## Sterile Nadel-Faden-Kombination











Needle - suture - combination, sterile

Nadel / needle	Stärke Nr. gauge no.		Länge/length m	Farbe/colour	Best.-Nr. code no.	Pckg.-Inhalt box content in Dtzd./dozen
	metric	USP				
● HRS 27 	3	2-0	0,75	blau/blue	770227	3
	3.5	0	0,75	blau/blue	770228	3
<b>1/2-Kreis schneidende Rundkörper = HRT</b> <i>1/2 circle, trocar point, round bodied = HRT</i>						
▼ HRT 18 	1	5-0	0,75	blau/blue	77061	3
	1.5	4-0	0,75	blau/blue	77062	3
	2	3-0	0,75	blau/blue	77063	3
▼ 2 x HRT 18 	1.5	4-0	0,90	blau/blue	77065	3
	2	3-0	0,90	blau/blue	77066	3
	3	2-0	0,90	blau/blue	77067	3
▼ HRT 22 	1.5	4-0	0,75	blau/blue	77068	3
	2	3-0	0,75	blau/blue	77069	3
	3	2-0	0,75	blau/blue	770610	3
▼ 2 x HRT 22 	1.5	4-0	0,90	blau/blue	770611	3
▼ HRT 25 	2	3-0	0,75	blau/blue	770615	3
	3	2-0	0,75	blau/blue	770616	3
	3.5	0	0,75	blau/blue	770621	3
▼ 2 x HRT 25 	2	3-0	0,90	blau/blue	770617	3
	3	2-0	0,90	blau/blue	770618	3
<b>3/8-Kreis Rundkörper = DR, DR F</b> <i>3/8 circle, round bodied = DR, DR F</i>						
● DR 10 	0.7	6-0	0,75	blau/blue	77074	3
● 2 x DR 10 	0.7	6-0	0,75	blau/blue	77075	3
	0.7	6-0	4 x 0,75	blau/blue	L 77076 Multi-L-Pack	1
● DR 10 F 	0.5	7-0	0,75	blau/blue	77071	3

# Resopren® PVDF-Faden

## Sterile Nadel-Faden-Kombination

Needle - suture - combination, sterile











Nadel / needle	Stärke Nr. gauge no.		Länge/length m	Farbe/colour	Best.-Nr. code no.	Pckg.-Inhalt box content in Dtzd./dozen
	metric	USP				
● 2 x DR 10 F 	0.5	7-0	0,75	blau/blue	77072	3
	0.5	7-0	4 x 0,75	blau/blue	L 77073 Multi-L-Pack	1
● DR 12 	1	5-0	0,75	blau/blue	770711	3
	1.5	4-0	0,75	blau/blue	770712	3
● 2 x DR 12 	1	5-0	0,75	blau/blue	770713	3
	1.5	4-0	0,75	blau/blue	770714	3
	1	5-0	0,90	blau/blue	770715	3
	1	5-0	4 x 0,90	blau/blue	L 770716 Multi-L-Pack	1
● DR 12 F 	0.7	6-0	0,75	blau/blue	77078	3
● 2 x DR 12 F 	0.7	6-0	0,75	blau/blue	77079	3
	0.7	6-0	4 x 0,75	blau/blue	L 770710 Multi-L-Pack	1
● DR 18 	1	5-0	0,75	blau/blue	770718	3
	1.5	4-0	0,75	blau/blue	770719	3
	2	3-0	0,75	blau/blue	770720	3
● 2 x DR 18 	1	5-0	0,90	blau/blue	770721	3
	1.5	4-0	0,90	blau/blue	770722	3
	2	3-0	0,90	blau/blue	770723	3
<p><b>3/8-Kreis schneidende Rundkörper = DRT, mit PREMIUM-Schliff = DRTM</b>  <i>3/8 circle, trocar point, round bodied = DRT, PREMIUM cut = DRTM</i></p>						
⊙ DRTM 10  PREMIUM-Schliff / PREMIUM cut	0.5	7-0	0,75	blau/blue	77251	2
	0.7	6-0	0,75	blau/blue	77252	2
⊙ 2 x DRTM 10  PREMIUM-Schliff / PREMIUM cut	0.5	7-0	0,75	blau/blue	77253	2
	0.7	6-0	0,75	blau/blue	77255	2
⊙ DRT 12 	0.7	6-0	0,75	blau/blue	77081	3
	1	5-0	0,75	blau/blue	77082	3



# Resopren® PVDF-Faden

## Sterile Nadel-Faden-Kombination







Needle - suture - combination, sterile

Nadel / needle	Stärke Nr. gauge no.		Länge/length m	Farbe/colour	Best.-Nr. code no.	Pckg.-Inhalt box content in Dtzd./dozen
	metric	USP				
<b>▼ 2 x DRT 12</b> 	0.7	6-0	0,75	blau/blue	77083	3
	1	5-0	0,75	blau/blue	77084	3
<b>▽ DRTM 12</b> 	0.7	6-0	0,75	blau/blue	77257	2
	1	5-0	0,75	blau/blue	77258	2
<b>▽ 2 x DRTM 12</b>  PREMIUM-Schliff / PREMIUM cut	0.7	6-0	0,75	blau/blue	772510	2
	1	5-0	0,75	blau/blue	772511	2
<b>▼ DRT 18</b> 	1	5-0	0,75	blau/blue	77086	3
	1.5	4-0	0,75	blau/blue	77087	3
	2	3-0	0,75	blau/blue	77088	3
<b>3/8-Kreis schneidende = DS, mit PREMIUM-Schliff = DSM, DSMF, DSMFX</b> <i>3/8 circle, reverse cutting = DS,            PREMIUM cut = DSM, DSMF, DSMFX</i>						
<b>▽ DSM 7</b>  PREMIUM-Schliff / PREMIUM cut	0.5	7-0	0,45	blau/blue	771518	3
	0.7	6-0	0,45	blau/blue	771519	3
<b>▽ DSM 11</b>  PREMIUM-Schliff / PREMIUM cut	0.7	6-0	0,45	blau/blue	771520	3
<b>▼ DS 13</b> 	1	5-0	0,45	blau/blue	771411	3
<b>▽ DSM 13</b>  PREMIUM-Schliff / PREMIUM cut	0.7	6-0	0,45	blau/blue	771526	3
	1	5-0	0,45	blau/blue	771517	3
	1.5	4-0	0,45	blau/blue	771527	3
<b>▽ DSMF 13</b>  PREMIUM-Schliff "fein" / PREMIUM cut "fine"	0.7	6-0	0,45	blau/blue	77221	3
	1	5-0	0,45	blau/blue	77222	3
<b>▼ DS 16</b>  PREMIUM-Schliff / PREMIUM cut	1	5-0	0,45	blau/blue	771415	3
	1.5	4-0	0,45	blau/blue	771412	3
<b>▽ DSM 16</b>  PREMIUM-Schliff / PREMIUM cut	1	5-0	0,45	blau/blue	771525	3
	1.5	4-0	0,45	blau/blue	77151	3

# Resopren® PVDF-Faden

## Sterile Nadel-Faden-Kombination







Needle - suture - combination, sterile

Nadel / needle	Stärke Nr. gauge no.		Länge/length m	Farbe/colour	Best.-Nr. code no.	Pckg.-Inhalt box content in Dtzd./dozen
	metric	USP				
▽ <b>DSMF 16</b> 	1	5-0	0,45	blau/blue	77223	3
	1.5	4-0	0,45	blau/blue	77224	3
PREMIUM-Schliff "fein" / <i>PREMIUM cut "fine"</i>	1	5-0	0,45	blau/blue	771401	3
▼ <b>DS 18</b> 	1.5	4-0	0,45	blau/blue	771402	3
	2	3-0	0,45	blau/blue	771403	3
	1.5	4-0	0,75	blau/blue	771416	3
	2	3-0	0,75	blau/blue	771417	3
	1.5	4-0	0,60	blau/blue	771404	2
					mit Intrakutanzubehör <i>Intracutaneous suture</i>	
	2	3-0	0,60	blau/blue	771405	2
				mit Intrakutanzubehör <i>Intracutaneous suture</i>		
▽ <b>DSM 18</b> 	1	5-0	0,45	blau/blue	77152	3
	1.5	4-0	0,45	blau/blue	77153	3
	2	3-0	0,45	blau/blue	77154	3
	1.5	4-0	0,75	blau/blue	771529	3
	2	3-0	0,75	blau/blue	77155	3
	3	2-0	0,75	blau/blue	771530	3
	1.5	4-0	0,60	blau/blue	77156	2
					mit Intrakutanzubehör <i>Intracutaneous suture</i>	
2	3-0	0,60	blau/blue	77157	2	
				mit Intrakutanzubehör <i>Intracutaneous suture</i>		
▽ <b>DSM 18 F</b> 	1.5	4-0	0,75	blau/blue	771522	3
PREMIUM-Schliff / <i>PREMIUM cut</i>						
▽ <b>DSMF 18</b> 	1	5-0	0,45	blau/blue	77225	3
	1.5	4-0	0,45	blau/blue	77226	3
	2	3-0	0,45	blau/blue	77227	3
	1.5	4-0	0,60	blau/blue	77228	2
					mit Intrakutanzubehör <i>Intracutaneous suture</i>	
2	3-0	0,60	blau/blue	77229	2	
				mit Intrakutanzubehör <i>Intracutaneous suture</i>		
▼ <b>DS 21</b> 	2	3-0	0,45	blau/blue	771420	3
	3	2-0	0,45	blau/blue	771421	3
	2	3-0	0,75	blau/blue	771422	3
	3	2-0	0,75	blau/blue	771423	3
▽ <b>DSM 21</b> 	2	3-0	0,45	blau/blue	771534	3
	1.5	4-0	0,75	blau/blue	771523	3
	2	3-0	0,75	blau/blue	771524	3
PREMIUM-Schliff / <i>PREMIUM cut</i>						

# Resopren® PVDF-Faden

## Sterile Nadel-Faden-Kombination

Needle - suture - combination, sterile

Nadel / needle	Stärke Nr. gauge no.		Länge/length m	Farbe/colour	Best.-Nr. code no.	Pckg.-Inhalt box content in Dtzd./dozen	
	metric	USP					
<b>▼ DS 24</b> 	1.5	4-0	0,45	blau/blue	771418	3	
	2	3-0	0,45	blau/blue	771406	3	
	3	2-0	0,45	blau/blue	771419	3	
	2	3-0	0,75	blau/blue	771407	3	
	3	2-0	0,75	blau/blue	771408	3	
	2	3-0	0,60	blau/blue	771409	2	
					mit Intrakutanzubehör <i>Intracutaneous suture</i>		
	3	2-0	0,60	blau/blue	771410	2	
				mit Intrakutanzubehör <i>Intracutaneous suture</i>			
<b>▽ DSM 24</b>  PREMIUM-Schliff / <i>PREMIUM cut</i>	1.5	4-0	0,45	blau/blue	771531	3	
	2	3-0	0,45	blau/blue	77158	3	
	3	2-0	0,45	blau/blue	771532	3	
	2	3-0	0,75	blau/blue	77159	3	
	3	2-0	0,75	blau/blue	771510	3	
	2	3-0	0,60	blau/blue	771511	2	
					mit Intrakutanzubehör <i>Intracutaneous suture</i>		
	3	2-0	0,60	blau/blue	771512	2	
				mit Intrakutanzubehör <i>Intracutaneous suture</i>			
<b>▽ DSMFX 24</b> 	2	3-0	0,45	blau/blue	772210	3	
	2	3-0	0,60	blau/blue	772211	2	
					mit Intrakutanzubehör <i>Intracutaneous suture</i>		
<b>▼ DS 27</b> 	3	2-0	0,45	blau/blue	771425	3	
	3	2-0	0,75	blau/blue	771426	3	
<b>▼ DS 30</b> 	2	3-0	0,75	blau/blue	771424	3	
	3	2-0	0,75	blau/blue	771413	3	
	3.5	0	0,75	blau/blue	771414	3	
<b>▽ DSM 30</b>  PREMIUM-Schliff / <i>PREMIUM cut</i>	2	3-0	0,75	blau/blue	771513	3	
	3	2-0	0,75	blau/blue	771514	3	
	3.5	0	0,75	blau/blue	771515	3	
<b>▼ DS 40</b> 	3	2-0	0,75	blau/blue	771427	3	

# Polyester

Polyester ist ein geflochtener und hochfester, nicht absorbierbarer Faden, der im Gewebe lange Zeit beständig bleibt, da er nicht durch Hydrolyse abgebaut werden kann. Polyester wird in den Farben grün und weiß angeboten.

- nichtabsorbierbarer Polyesterfaden
- extrem zugfest
- hydrophob
- alterungsbeständig
- geringe Gewebereaktion

Polyester

# *Polyester*

*Polyester is a braided non-absorbable suture that retains its strength in vivo for a long time since it is not altered by hydrolysis.*









*Polyester is available in green and white.*

- *non-absorbable polyester suture*
- *high and permanent tensile strength*
- *water-repellent*
- *minimal tissue reactions*

# POLYESTER

## Sterile Nadel-Faden-Kombination





Needle - suture - combination, sterile

Nadel / needle	Stärke Nr. gauge no.		Länge/length m	Farbe/colour	Best.-Nr. code no.	Pckg.-Inhalt box content in Dtzd./dozen
	metric	USP				
<b>1/2-Kreis Rundkörper = HR, HRS</b> <i>1/2 circle, round bodied = HR, HRS</i>						
● HR 10 	1.5	4-0	0,45	grün/green	8021	3
● HR 17 	1	5-0	0,75	grün/green	8022	3
	1.5	4-0	0,75	grün/green	8023	3
	2	3-0	0,75	grün/green	8024	3
	3	2-0	0,75	grün/green	8025	3
● 2 x HR 17 	1	5-0	0,90	grün/green	8026	3
	1.5	4-0	0,90	grün/green	80231	3
	2	3-0	0,90	grün/green	80232	3
● HR 22 	1.5	4-0	0,75	grün/green	80210	3
	2	3-0	0,75	grün/green	80211	3
	3	2-0	0,75	grün/green	80212	3
● HR 27 	2	3-0	0,75	grün/green	80215	3
	3	2-0	0,75	grün/green	80216	3
	3.5	0	0,75	grün/green	80217	3
	4	1	0,75	grün/green	80218	3
● 2 x HR 27 	2	3-0	0,90	grün/green	80221	3
	3	2-0	0,90	grün/green	80222	3
● HR 35 	3	2-0	0,75	grün/green	80224	3
	3.5	0	0,75	grün/green	80225	3
	4	1	0,75	grün/green	80226	3
● HRS 35 	3	2-0	0,75	grün/green	8031	3
	3.5	0	0,75	grün/green	8032	3
<b>1/2-Kreis schneidende Rundkörper = HRT</b> <i>1/2 circle, round bodied, trocar point = HRT</i>						
▼ HRT 18 	2	3-0	0,45	grün/green	80616	3
	1	5-0	0,75	grün/green	8061	3
	1.5	4-0	0,75	grün/green	8062	3
	2	3-0	0,75	grün/green	8063	3

# POLYESTER

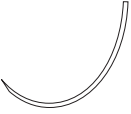
## Sterile Nadel-Faden-Kombination

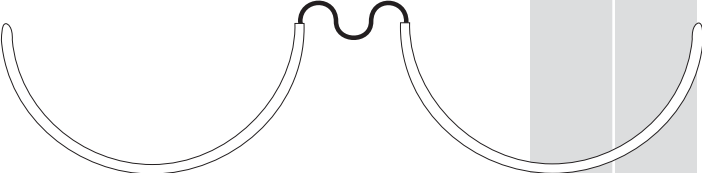







Needle - suture - combination, sterile

Nadel / needle	Stärke Nr. gauge no.		Länge/length m	Farbe/colour	Best.-Nr. code no.	Pckg.-Inhalt box content in Dtzd./dozen
	metric	USP				
<b>Asymptotische schneidende Rundkörper = ART</b> <i>Asymptotic, round bodied, trocar point = ART</i>						
▼ ART 13 	1.5	4-0	0,45	grün/green	8281	1
▼ ART 25 	1.5 2	4-0 3-0	0,45 0,45	grün/green grün/green	8282 8283	1 1
<b>1/2-Kreis Rundkörper stumpf = HRN</b> <i>1/2 circle, round bodied, blunt point = HRN</i>						
○ 2 x HRN 35  Cervix-Naht nach SHIRODKAR <i>Cervix Suture acc. to SHIRODKAR</i>	9	7	0,40 0,40	weiß/white weiß/white	C 8055 C 8056	1 1
	Polyesterband 5mm <i>5mm strip</i>					
○ 2 x HRN 50  Cervix-Naht nach SHIRODKAR <i>Cervix Suture acc. to SHIRODKAR</i>	9	7	0,40 0,40	weiß/white weiß/white	C 8051 C 8052	1 1
	Polyesterband 5mm <i>5mm strip</i>					
○ 2 x HRN 65  Cervix-Naht nach SHIRODKAR <i>Cervix Suture acc. to SHIRODKAR</i>	9	7	0,40 0,40	weiß/white weiß/white	C 8053 C 8054	1 1
	Polyesterband 5mm <i>5mm strip</i>					
<b>1/2-Kreis schneidende = HS</b> <i>1/2 circle, reverse cutting = HS</i>						
▼ HS 18 	1 2 2	5-0 3-0 3-0	0,45 0,45 0,75	grün/green grün/green grün/green	8111 8112 8117	3 3 3

# POLYESTER

## Sterile Nadel-Faden-Kombination











Needle - suture - combination, sterile

Nadel / needle	Stärke Nr. gauge no.		Länge/length m	Farbe/colour	Best.-Nr. code no.	Pckg.-Inhalt box content in Dtzd./dozen
	metric	USP				
▼ HS 22 	2	3-0	0,45	grün/green	8113	3
▼ HS 27 	3.5	0	0,75	grün/green	8114	3
▼ HS 35 	4	1	0,75	grün/green	8115	3
▼ HS 40 	4	1	0,75	grün/green	8116	3
<p><b>3/8-Kreis schneidende = DS, DS F mit PREMIUM-Schliff = DSM, DSM F</b>  <i>3/8 circle, reverse cutting = DS, DS F, Premium cut = DSM, DSM F</i></p>						
▽ DSM 11  PREMIUM-Schliff / PREMIUM cut	0.7	6-0	0,45	grün/green	8151	3
▼ DS 13 	1	5-0	0,45	grün/green	8141	3
▽ DSM 13  PREMIUM-Schliff / PREMIUM cut	1 1.5	5-0 4-0	0,45 0,45	grün/green grün/green	8156 8157	3 3
▼ DS 16 	0.7 1 1.5	6-0 5-0 4-0	0,45 0,45 0,45	grün/green grün/green grün/green	8147 8148 8149	3 3 3
▽ DSM 16  PREMIUM-Schliff / PREMIUM cut	1 1.5	5-0 4-0	0,45 0,45	grün/green grün/green	81513 81514	3 3

# POLYESTER

## Sterile Nadel-Faden-Kombination

Needle - suture - combination, sterile







Nadel / needle	Stärke Nr. gauge no.		Länge/length m	Farbe/colour	Best.-Nr. code no.	Pckg.-Inhalt box content in Dtzd./dozen
	metric	USP				
▼ DS 18 	1	5-0	0,45	grün/green	81411	3
	1.5	4-0	0,45	grün/green	81412	3
	2	3-0	0,45	grün/green	81413	3
	2	3-0	4 x 0,45	grün/green	M 81416 Multipack	2
▼ 2 x DS 18 	1.5	4-0	0,75	grün/green	81417	3
▼ DS 18 F 	1.5	4-0	0,45	grün/green	81430	3
▽ DSM 18  PREMIUM-Schliff / PREMIUM cut	1.5	4-0	0,45	grün/green	81515	3
	2	3-0	0,45	grün/green	81516	3
	3	2-0	0,45	grün/green	81517	3
▽ DSM 18 F  PREMIUM-Schliff / PREMIUM cut	1.5	4-0	0,45	grün/green	81524	3
▼ DS 21 	1.5	4-0	0,45	grün/green	81427	3
	2	3-0	0,45	grün/green	81428	3
	3	2-0	0,45	grün/green	81429	3
▽ DSM 21  PREMIUM-Schliff / PREMIUM cut	1.5	4-0	0,45	grün/green	81520	3
	2	3-0	0,45	grün/green	81521	3
	3	2-0	0,45	grün/green	81522	3
▼ DS 24 	2	3-0	0,45	grün/green	81418	3
	3	2-0	0,45	grün/green	81419	3
	2	3-0	0,45	weiß/white	81420	3
	2	3-0	0,75	grün/green	81437	3
	3	2-0	0,75	grün/green	81434	3
▽ DSM 24  PREMIUM-Schliff / PREMIUM cut	3	2-0	0,75	grün/green	81519	3
▼ DS 27 	3	2-0	0,45	weiß/white	81421	3



# POLYESTER

## Sterile Nadel-Faden-Kombination

Needle - suture - combination, sterile

Nadel / needle	Stärke Nr. gauge no.		Länge/length m	Farbe/colour	Best.-Nr. code no.	Pckg.-Inhalt box content in Dtzd./dozen
	metric	USP				
<b>▽ DSM 27</b>  PREMIUM-Schliff / PREMIUM cut	3	2-0	0,75	grün/green	81523	3
<b>▼ DS 30</b> 	2	3-0	0,45	weiß/white	81424	3
	3	2-0	0,45	weiß/white	81425	3
	3.5	0	0,45	grün/green	81435	3
	3	2-0	0,75	grün/green	81422	3
	3.5	0	0,75	grün/green	81423	3
	4	1	0,75	grün/green	81436	3
<b>▼ DS 80</b> 	Ø 1,0 mm		1,50	weiß/white	81426	1
<b>Gerade schneidende = GS</b> <i>straight, cutting = GS</i>						
<b>▼ GS 60</b> 	3	2-0	0,75	grün/green	8173	3
<b>1/2-Kreis schneidende Spatula, PREMIUM-Schliff = HSPM</b> <i>1/2 circle, spatulated, Premium cut = HSPM</i>						
<b>▽ 2 x HSPM 8</b>  PREMIUM-Schliff / PREMIUM cut	1.5	4-0	0,45	weiß/white	8192	2
<b>1/4-Kreis schneidende Spatula, PREMIUM-Schliff = VSPM, VSPM F</b> <i>1/2 circle, spatulated, Premium cut = VSPM, VSPM F</i>						
<b>▽ 2 x VSPM 8</b>  PREMIUM-Schliff / PREMIUM cut	1.5	4-0	0,45	weiß/white	8217	2
<b>▽ 2 x VSPM 8 F</b>  PREMIUM-Schliff / PREMIUM cut	0.7	6-0	0,45	weiß/white	8211	2
	1	5-0	0,45	weiß/white	8212	2
	1.5	4-0	0,45	weiß/white	8213	2

# POLYESTER

Einzelfadenpackungen, steril in vorgeschnittenen Längen

Sterile pre-cut suture, non-neededled

Stärke Nr. gauge no. metric		USP	Länge/length m	Farbe/colour	Best.-Nr. code no.	Pckg.-Inhalt box content in Dtzd./dozen
1.5	4-0		5 x 0,35	grün/green	R 353	2
2	3-0		5 x 0,35	grün/green	R 453	2
3	2-0		5 x 0,35	grün/green	R 553	2
3.5	0		5 x 0,35	grün/green	R 653	2
4	1		5 x 0,35	grün/green	R 753	2
2	3-0		5 x 0,35	weiß/white	WR 453	2
3	2-0		5 x 0,35	weiß/white	WR 553	2
1	5-0		3 x 0,50	grün/green	R 235	2
1.5	4-0		3 x 0,50	grün/green	R 335	2
2	3-0		3 x 0,50	grün/green	R 435	2
3	2-0		3 x 0,50	grün/green	R 535	2
3.5	0		3 x 0,50	grün/green	R 635	2
4	1		3 x 0,50	grün/green	R 735	2
5	2		3 x 0,50	grün/green	R 835	2
6	3		3 x 0,50	grün/green	R 935	2
2	3-0		3 x 0,50	schwarz/black	SAR 435	2
3	2-0		3 x 0,50	schwarz/black	SAR 535	2
3.5	0		3 x 0,50	schwarz/black	SAR 635	2
2	3-0		3 x 0,50	weiß/white	WR 435	2
3	2-0		3 x 0,50	weiß/white	WR 535	2
3.5	0		3 x 0,50	weiß/white	WR 635	2
5	2		3 x 0,50	weiß/white	WR 835	2
1	5-0		5 x 0,50	grün/green	R 255	2
1.5	4-0		5 x 0,50	grün/green	R 355	2
2	3-0		5 x 0,50	grün/green	R 455	2
3	2-0		5 x 0,50	grün/green	R 555	2
3.5	0		5 x 0,50	grün/green	R 655	2
4	1		5 x 0,50	grün/green	R 755	2
5	2		5 x 0,50	grün/green	R 855	2
2	3-0		5 x 0,50	weiß/white	WR 455	2
3	2-0		5 x 0,50	weiß/white	WR 555	2
3.5	0		5 x 0,50	weiß/white	WR 655	2
1.5	4-0		6 x 0,50	grün/green	SR 355	2
2	3-0		6 x 0,50	grün/green	SR 455	2
3	2-0		6 x 0,50	grün/green	SR 555	2
3.5	0		6 x 0,50	grün/green	SR 655	2
4	1		6 x 0,50	grün/green	SR 755	2
5	2		6 x 0,50	grün/green	SR 855	2
2	3-0		10 x 0,50	grün/green	R 4105	2
3	2-0		10 x 0,50	grün/green	R 5105	2
3.5	0		10 x 0,50	grün/green	R 6105	2

# POLYESTER

## Einzelfadenpackungen, steril in vorgeschnittenen Längen

*Sterile pre-cut suture, non-neededled*

Stärke Nr. gauge no.		Länge/length m	Farbe/colour	Best.-Nr. code no.	Pckg.-Inhalt box content in Dtzd./dozen
metric	USP				
3.5	0	10 x 0,50	weiß/white	WR 6105	2
2	3-0	12 x 0,50	grün/green	SR 4105	2
3	2-0	12 x 0,50	grün/green	SR 5105	2
3.5	0	12 x 0,50	grün/green	SR 6105	2
2	3-0	2 x 0,75	grün/green	R 420	2
3	2-0	2 x 0,75	grün/green	R 520	2
3.5	0	2 x 0,75	grün/green	R 620	2
4	1	2 x 0,75	grün/green	R 720	2
5	2	2 x 0,75	grün/green	R 820	2
6	3	2 x 0,75	grün/green	R 920	2
2	3-0	2 x 0,75	weiß/white	WR 420	2
3	2-0	2 x 0,75	weiß/white	WR 520	2
3.5	0	2 x 0,75	weiß/white	WR 620	2
4	1	2 x 0,75	weiß/white	WR 720	2
2	3-0	5 x 0,75	grün/green	R 450	2
3	2-0	5 x 0,75	grün/green	R 550	2
3.5	0	5 x 0,75	grün/green	R 650	2
4	1	5 x 0,75	grün/green	R 750	2
5	2	5 x 0,75	grün/green	R 850	2
3.5	0	1 x 1,20	grün/green	R 612	2
4	1	1 x 1,40	grün/green	SR 712	2
5	2	1 x 1,40	grün/green	SR 812	2

## Supolene®

Supolene® ist, wie Polyester, ein geflochtenes und nicht absorbierbares, grün gefärbtes Fadenmaterial, das im Gewebe beständig ist, da es nicht durch Hydrolyse abgebaut werden kann. Das Nahtmaterial wird durch die Beschichtung der Fadenoberfläche zur Verbesserung des Gewebedurchzugs sowie der Knüpfeigenschaften veredelt.

- nichtabsorbierbarer Polyesterfaden
- extrem zugfest
- hydrophob
- alterungsbeständig
- kaum Sägewirkung beim Gewebedurchzug
- sehr gewebefreundlich

Supolene

## Supolene®











*Supolene® is, like Polyester, a braided non-absorbable green-dyed suture, that retains its tensile strength in vivo as it is not altered by hydrolysis. The quality is upgraded by coating the surface of the braided strand to improve knotting properties and passage through tissue.*

- *non-absorbable suture*
- *high and permanent tensile strength*
- *water-repellent*
- *provides long-term support in tissue*
- *smooth tissue passage*
- *completely non-irritating*

# SUPOLENE®

## Sterile Nadel-Faden-Kombination







Needle - suture - combination, sterile

Nadel / needle	Stärke Nr. gauge no.		Länge/length m	Farbe/colour	Best.-Nr. code no.	Pckg.-Inhalt box content in Dtzd./dozen
	metric	USP				
<b>1/2-Kreis Rundkörper = HR, HRX</b> 1/2 circle, round bodied = HR, HRX						
● HR 12 	1	5-0	0,75	grün/green	9021	3
	1.5	4-0	0,75	grün/green	9022	3
● HR 12 A  Abziehnadel/control release needle	1.5	4-0	8 x 0,45	grün/green	A 90232 Multipack	1
● 2 x HR 15 	1	5-0	0,75	grün/green	9024	3
● HR 17 	1	5-0	0,75	grün/green	9025	3
	1.5	4-0	0,75	grün/green	9026	3
	2	3-0	0,75	grün/green	9027	3
	3	2-0	0,75	grün/green	9028	3
● HR 17 A  Abziehnadel/control release needle	1.5	4-0	8 x 0,45	grün/green	A 90238 Multipack	1
● 2 x HR 17 	1.5	4-0	0,90	grün/green	90210	3
	2	3-0	0,90	grün/green	90214	3
● HR 22 	1.5	4-0	0,75	grün/green	90215	3
	2	3-0	0,75	grün/green	90216	3
	3	2-0	0,75	grün/green	90217	3
● HR 27 	2	3-0	0,75	grün/green	90218	3
	3	2-0	0,75	grün/green	90219	3
	3.5	0	0,75	grün/green	90220	3
	4	1	0,75	grün/green	90221	3
	3	2-0	6 x 0,75	grün/green	M 90222 Multipack	1
	5	2	0,75	grün/green	9041	2
● 2 x HRX 27 	5	2	0,75	grün/green	9041	2
● HR 30 	3.5	0	0,75	grün/green	90228	3

# SUPOLENE®

## Sterile Nadel-Faden-Kombination

Needle - suture - combination, sterile





Nadel / needle	Stärke Nr. gauge no.		Länge/length m	Farbe/colour	Best.-Nr. code no.	Pckg.-Inhalt box content in Dtzd./dozen
	metric	USP				
<b>● HR 35</b> 	3.5	0	0,75	grün/green	90230	3
	4	1	0,75	grün/green	90231	3
<div style="background-color: #cccccc; padding: 5px;"> <b>1/2-Kreis schneidende Rundkörper = HRT, HRTX</b>  <i>1/2 circle, round bodied, trocar point = HRT, HRTX</i> </div>						
<b>▼ HRT 18</b> 	1	5-0	0,75	grün/green	9061	3
	1.5	4-0	0,75	grün/green	9062	3
	2	3-0	0,75	grün/green	9063	3
	3	2-0	0,75	grün/green	9064	3
	3.5	0	0,75	grün/green	90652	3
<b>▼ 2 x HRT 18</b> 	1.5	4-0	0,75	grün/green	9067	3
	2	3-0	0,75	grün/green	9068	3
	3	2-0	0,75	grün/green	9069	3
	3.5	0	0,75	grün/green	90610	3
	3	2-0	4 x 0,75	grün/green	M 90614 Multipack	2
	3	2-0	4 x 0,75	grün/weiß green/white	M 90636 Multipack	2
	3	2-0	4 x 0,75	grün/weiß green/white + Teflon-Pledgets 6 x 3 mm	M 90653 Multipack	1
<b>▼ HRT 25</b> 	2	3-0	0,75	grün/green	90616	3
	3	2-0	0,75	grün/green	90617	3
	3.5	0	0,75	grün/green	90618	3
	3	2-0	4 x 0,75	grün/weiß green/white + Teflon-Pledgets 6 x 3 mm	M 90654 Multipack	1
<b>▼ HRT 45</b> 	5	2	0,75	grün/green	90626	2
<b>▼ HRTX 45</b> 	8	6	0,75	grün/green	C 90627	1

Cervix-Naht nach MC DONALD  
Cervix Suture acc. to MC DONALD

# SUPOLENE®

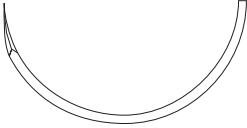
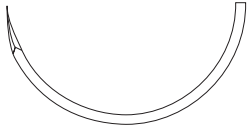
## Sterile Nadel-Faden-Kombination

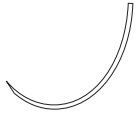

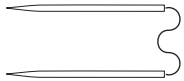
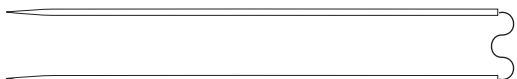





Needle - suture - combination, sterile

Nadel / needle	Stärke Nr. gauge no.		Länge/length m	Farbe/colour	Best.-Nr. code no.	Pckg.-Inhalt box content in Dtzd./dozen
	metric	USP				
<b>▼ HRT 50</b> 	8	6	6 x 0,75	grün/green	M 90631 Multipack	1
<b>▼ HRTX 50</b> 	8	6	0,75	grün/green	C 90628	1
Cervix-Naht nach MC DONALD Cervix Suture acc. to MC DONALD						
<b>Asymptotische schneidende Rundkörper = ART</b> <i>Asymptotic, round bodied, trocar point = ART</i>						
<b>▼ ART 13</b> 	1.5	4-0	0,45	grün/green	9281	1
<b>▼ ART 25</b> 	1.5 2	4-0 3-0	0,45 0,45	grün/green grün/green	9282 9283	1 1
<b>3/8-Kreis Rundkörper = DR F</b> <i>3/8 circle, round bodied = DR F</i>						
<b>● DR 10 F</b> 	0.7	6-0	0,75	grün/green	9071	3
<b>Gerade Rundkörper = GR</b> <i>Straight round bodied = GR</i>						
<b>● GR 20</b> 	2	3-0	0,45	grün/green	9091	3
<b>● 2 x GR 20</b> 	1.5	4-0	0,35	grün/green	9093	3
<b>● 2 x GR 65</b> 	6	3	0,75	grün/green	9094	2

# SUPOLENE®

## Sterile Nadel-Faden-Kombination

Needle - suture - combination, sterile











Nadel / needle	Stärke Nr. gauge no.		Länge/length m	Farbe/colour	Best.-Nr. code no.	Pckg.-Inhalt box content in Dtzd./dozen
	metric	USP				
<b>3/8-Kreis schneidende Rundkörper = DRT</b> <i>3/8 circle, round bodied, trocar point = DRT</i>						
▼ DRT 12 	0.7	6-0	0,75	grün/green	9081	3
	1	5-0	0,75	grün/green	9082	3
▼ DRT 18 	2	3-0	0,75	grün/green	9087	3
	3	2-0	0,75	grün/green	9088	3
<b>1/2-Kreis schneidende = HS</b> <i>1/2 circle, reverse cutting = HS</i>						
▼ HS 18 	2	3-0	0,45	grün/green	9111	3
▼ HS 22 	2	3-0	0,75	grün/green	9112	3
	3	2-0	0,75	grün/green	9113	3
▼ HS 27 	3.5	0	0,75	grün/green	9115	3
▼ HS 35 	4	1	0,75	grün/green	9116	3
▼ HS 40 	4	1	0,75	grün/green	9117	3
<b>3/8-Kreis schneidende = DS, DS F, mit PREMIUM-Schliff = DSM</b> <i>3/8 circle, reverse cutting = DS, DSF, Premium cut = DSM</i>						
▽ DSM 11  PEREMIUM-Schliff   PREMIUM cut	0.7	6-0	0,45	grün/green	9151	3



# SUPOLENE®

## Sterile Nadel-Faden-Kombination







Needle - suture - combination, sterile

Nadel / needle	Stärke Nr. gauge no.		Länge/length m	Farbe/colour	Best.-Nr. code no.	Pckg.-Inhalt box content in Dtzd./dozen
	metric	USP				
▼ DS 13 	1.5	4-0	0,45	grün/green	9142	3
▽ DSM 13 	1	5-0	0,45	grün/green	9152	3
	1.5	4-0	0,45	grün/green	9153	3
PEREMIUM-Schliff / PREMIUM cut						
▽ DSM 16 	1	5-0	0,45	grün/green	9155	3
	1.5	4-0	0,45	grün/green	9156	3
PEREMIUM-Schliff / PREMIUM cut						
▼ DS 18 	1	5-0	0,45	grün/green	9144	3
	1.5	4-0	0,45	grün/green	9145	3
	2	3-0	0,45	grün/green	9146	3
	2	3-0	6 x 0,50	grün/green	M 91436 Multipack	1
▼ DS 18 F 	1.5	4-0	0,45	grün/green	91427	3
▽ DSM 18 	1.5	4-0	0,45	grün/green	9157	3
	2	3-0	0,45	grün/green	9158	3
	3	2-0	0,45	grün/green	9159	3
	1.5	4-0	0,75	grün/green	91526	3
	2	3-0	4 x 0,45	grün/green	M 91515 Multipack	2
▼ DS 21 	1.5	4-0	0,45	grün/green	91423	3
	2	3-0	0,45	grün/green	91424	3
	3	2-0	0,45	grün/green	91425	3
▽ DSM 21 	1.5	4-0	0,45	grün/green	91516	3
	2	3-0	0,45	grün/green	91517	3
	3	2-0	0,45	grün/green	91518	3
▼ DS 24 	1.5	4-0	0,45	grün/green	9147	3
	2	3-0	0,45	grün/green	9148	3
	3	2-0	0,45	grün/green	9149	3
	2	3-0	0,75	grün/green	91410	3
	3.5	0	0,75	grün/green	91433	3
▽ DSM 24 	2	3-0	0,45	grün/green	91512	3
	2	3-0	0,75	grün/green	91513	3
	3	2-0	0,75	grün/green	91514	3
PEREMIUM-Schliff / PREMIUM cut						

# SUPOLENE®

## Sterile Nadel-Faden-Kombination

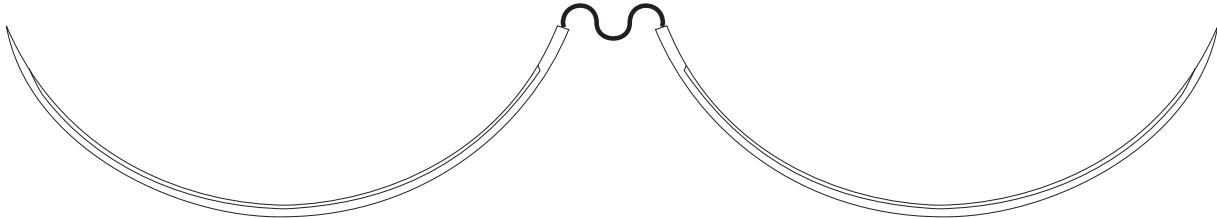

Needle - suture - combination, sterile

Nadel / needle	Stärke Nr. gauge no.		Länge/length m	Farbe/colour	Best.-Nr. code no.	Pckg.-Inhalt box content in Dtzd./dozen
	metric	USP				
▼ DS 27 	3	2-0	0,45	grün/green	91411	3
	3	2-0	0,75	grün/green	91426	3
▽ DSM 27  PEREMIUM-Schliff / PREMIUM cut	3	2-0	0,45	grün/green	91520	3
	3	2-0	0,75	grün/green	91519	3
▼ DS 30 	3	2-0	0,75	grün/green	91412	3
	3.5	0	0,75	grün/green	91413	3
	4	1	0,75	grün/green	91428	3
▽ DSM 30  PEREMIUM-Schliff / PREMIUM cut	3	2-0	0,75	grün/green	91521	3
	3.5	0	0,75	grün/green	91522	3
▼ DS 40 	3	2-0	0,75	grün/green	91435	3
	3.5	0	0,75	grün/green	91414	3
▼ DS 50 	4	1	0,75	grün/green	91434	3
▼ 2 x DS 90 						
Doppelte Unterstützungsnaht Tension Suture, double-armed	7	5	0,75	grün/green	91415 U	1/2
	8	6	0,75	grün/green	91416 U	1/2
Zubehör: Je 2 Nylonplatten 80 x 23 mm und 2 Moosgummiplatten 82 x 25 mm Incl. 4 buttons						

# SUPOLENE®

## Sterile Nadel-Faden-Kombination

Needle - suture - combination, sterile

Nadel / needle	Stärke Nr. gauge no.		Länge/length m	Farbe/colour	Best.-Nr. code no.	Pckg.-Inhalt box content in Dtzd./dozen
	metric	USP				
<b>Gerade schneidende = GS</b> <i>Straight, cutting = GS</i>						
▼ <b>GS 60</b>	3.5	0	0,45	grün/green	9178	3
	3	2-0	0,75	grün/green	9174	3
<b>1/2-Kreis gebogene schneidende = KS</b> <i>1/2 circle, curved, reverse cutting = KS</i>						
▼ <b>KS 20</b>	2	3-0	0,45	grün/green	9181	3
						
<b>1/4-Kreis schneidende Spatula, handgeschliffen = VSPM F</b> <i>1/4 circle, spatulated, hand-honed = VSPM F</i>						
▽ <b>2 x VSPM 8 F</b>	0.7	6-0	0,45	weiß/white	9211	2
	1	5-0	0,45	weiß/white	9212	2
PEREMIUM-Schliff   <i>PREMIUM cut</i>						

# SUPOLENE®

Einzelfadenpackungen, steril in vorgeschnittenen Längen

Needle - suture - combination, sterile

Stärke Nr. gauge no. metric		USP	Länge/length m	Farbe/colour	Best.-Nr. code no.	Pckg.-Inhalt box content in Dtzd./dozen
2	3-0		5 x 0,35	grün/green	W 453	2
3	2-0		5 x 0,35	grün/green	W 553	2
3.5	0		5 x 0,35	grün/green	W 653	2
1.5	4-0		3 x 0,50	grün/green	W 335	2
2	3-0		3 x 0,50	grün/green	W 435	2
3	2-0		3 x 0,50	grün/green	W 535	2
3.5	0		3 x 0,50	grün/green	W 635	2
4	1		3 x 0,50	grün/green	W 735	2
5	2		3 x 0,50	grün/green	W 835	2
1.5	4-0		5 x 0,50	grün/green	W 355	2
2	3-0		5 x 0,50	grün/green	W 455	2
3	2-0		5 x 0,50	grün/green	W 555	2
3.5	0		5 x 0,50	grün/green	W 655	2
4	1		5 x 0,50	grün/green	W 755	2
5	2		5 x 0,50	grün/green	W 855	2
1.5	4-0		6 x 0,50	grün/green	SW 355	2
2	3-0		6 x 0,50	grün/green	SW 455	2
3	2-0		6 x 0,50	grün/green	SW 555	2
3.5	0		6 x 0,50	grün/green	SW 655	2
4	1		6 x 0,50	grün/green	SW 755	2
5	2		6 x 0,50	grün/green	SW 855	2
1.5	4-0		10 x 0,50	grün/green	W 3105	2
2	3-0		10 x 0,50	grün/green	W 4105	2
3	2-0		10 x 0,50	grün/green	W 5105	2
3	2-0		12 x 0,50	grün/green	SW 5105	2
3.5	0		12 x 0,50	grün/green	SW 6105	2
4	1		12 x 0,50	grün/green	SW 7105	2
2	3-0		17 x 0,50	grün/green	W 4175	2
3	2-0		2 x 0,75	grün/green	W 520	2
3.5	0		2 x 0,75	grün/green	W 620	2
4	1		2 x 0,75	grün/green	W 720	2
5	2		2 x 0,75	grün/green	W 820	2
6	3		2 x 0,75	grün/green	W 920	2
4	1		5 x 0,75	grün/green	W 750	2
5	2		5 x 0,75	grün/green	W 850	2
6	3		5 x 0,75	grün/green	W 950	2

# Nylon

Nylon, erhältlich in schwarz ist ein monofiler, nichtabsorbierbarer Polyamidfaden. Durch die hohe Reißfestigkeit ist Nylon selbst bei geringem Fadendurchmesser für feinste Nähte geeignet.

- nichtabsorbierbares Material
- überdurchschnittlich geschmeidig und weich
- sehr gute Knüpfenschaften
- hervorragender Gewebedurchzug
- keine Kapillarität
- geringe Gewebereaktion

## Nylon (Polyamide)









*Nylon (available in black) is a monofilament, non-absorbable suture of polyamide. Due to its high tensile strength, even with small diameters, it is frequently used for the finest sutures.*

- *non-absorbable suture*
- *very soft and supple*
- *perfect handling and knotting*
- *easy passage through tissue*
- *no capillarity*
- *minimal tissue reactions*

# NYLON monofil

## Sterile Nadel-Faden-Kombination











Needle - suture - combination, sterile

Nadel / needle	Stärke Nr. gauge no.		Länge/length m	Farbe/colour	Best.-Nr. code no.	Pckg.-Inhalt box content in Dtzd./dozen
	metric	USP				
<b>1/2-Kreis Rundkörper = HR F</b> <i>1/2 circle, round bodied = HR F</i>						
● 2 x HR 6 F 	0.2	10-0	0,10	schwarz/black	5021	2
<b>3/8-Kreis Rundkörper = DR, DR F</b> <i>3/8 circle, round bodied = DR, DR F</i>						
● DR 4 	0.1	11-0	0,10	schwarz/black	50713	2
	0.2	10-0	0,10	schwarz/black	50714	2
● DR 5 F 	0.2	10-0	0,15	schwarz/black	5071	2
	0.3	9-0	0,15	schwarz/black	5072	2
● 2 x DR 5 F 	0.2	10-0	0,15	schwarz/black	5073	2
● DR 6 	0.2	10-0	0,15	schwarz/black	5074	2
	0.3	9-0	0,15	schwarz/black	5075	2
	0.4	8-0	0,15	schwarz/black	5076	2
● DR 10 F 	0.5	7-0	0,45	schwarz/black	5079	3
● DR 12 F 	0.7	6-0	0,75	schwarz/black	50711	3
	1	5-0	0,75	schwarz/black	50712	3
<b>3/8-Kreis schneidender Rundkörper, mit PREMIUM-Schliff = DTRM</b> <i>3/8 circle, trocar point, round bodied, PREMIUM cut= DTRM</i>						
◊ DRTM 5  PREMIUM-Schliff / PREMIUM cut	0.2	10-0	0,15	schwarz/black	5251	2
<b>1/2-Kreis schneidende = HS, mit PREMIUM-Schliff = HSM</b> <i>1/2 circle, reverse cutting = HS, PREMIUM cut = HSM</i>						
▽ 2 x HSM 8  PREMIUM-Schliff / PREMIUM cut	0.3	9-0	0,45	schwarz/black	5121	2

# NYLON monofil

## Sterile Nadel-Faden-Kombination









Needle - suture - combination, sterile

Nadel / needle	Stärke Nr. gauge no.		Länge/length m	Farbe/colour	Best.-Nr. code no.	Pckg.-Inhalt box content in Dtzd./dozen
	metric	USP				
▼ HS 12 	1	5-0	0,45	schwarz/black	5111	3
▽ HSM 17  PREMIUM-Schliff / PREMIUM cut	1.5	4-0	0,45	schwarz/black	5126	3
<b>3/8-Kreis schneidende = DS, DS F, mit PREMIUM-Schliff = DSM, DSM F</b> <i>3/8 circle, reverse cutting = DS, DS F, PREMIUM cut = DS, DSM F</i>						
▽ DSM 6  PREMIUM-Schliff / PREMIUM cut	0.2	10-0	0,30	schwarz/black	5152	2
▽ DSM 7  PREMIUM-Schliff / PREMIUM cut	0.5	7-0	0,45	schwarz/black	5155	3
▽ DSM 11  PREMIUM-Schliff / PREMIUM cut	0.5 0.7	7-0 6-0	0,45 0,45	schwarz/black schwarz/black	5156 5157	3 3
▼ DS 13 	0.7 1 1.5	6-0 5-0 4-0	0,45 0,45 0,45	schwarz/black schwarz/black schwarz/black	5142 5143 5144	3 3 3
▽ DSM 13  PREMIUM-Schliff / PREMIUM cut	1 1.5	5-0 4-0	0,45 0,45	schwarz/black schwarz/black	51513 51514	3 3
▼ DS 16 	0.7 1	6-0 5-0	0,45 0,45	schwarz/black schwarz/black	5145 5146	3 3
▽ DSM 16  PREMIUM-Schliff / PREMIUM cut	1.5	4-0	0,45	schwarz/black	51517	3
▼ DS 18 	1 1.5 2 3 1.5 1 1.5 2	5-0 4-0 3-0 2-0 4-0 5-0 4-0 3-0	0,45 0,45 0,45 0,45 0,45 0,75 0,75 0,75	schwarz/black schwarz/black schwarz/black schwarz/black schwarz/black weiß/white schwarz/black schwarz/black schwarz/black	5147 5148 5149 51423 51414 51444 51445 51410	3 3 3 3 3 3 3 3

# NYLON monofil

## Sterile Nadel-Faden-Kombination

Needle - suture - combination, sterile

















Nadel / needle	Stärke Nr. gauge no.		Länge/length m	Farbe/colour	Best.-Nr. code no.	Pckg.-Inhalt box content in Dtzd./dozen
	metric	USP				
▼ <b>DS 18 F</b> 	1.5	4-0	0,45	schwarz/black	51442	3
▽ <b>DSM 18</b>  PREMIUM-Schliff / PREMIUM cut	1.5	4-0	0,45	schwarz/black	51519	3
	2	3-0	0,45	schwarz/black	51520	3
	3	2-0	0,45	schwarz/black	51521	3
	2	3-0	0,75	schwarz/black	51522	3
▽ <b>DSM 18 F</b>  PREMIUM-Schliff / PREMIUM cut	1.5	4-0	0,45	schwarz/black	51539	3
▼ <b>DS 21</b> 	1.5	4-0	0,45	schwarz/black	51439	3
	2	3-0	0,45	schwarz/black	51440	3
▼ <b>DS 24</b> 	2	3-0	0,45	schwarz/black	51415	3
	2	3-0	0,75	schwarz/black	51416	3
▽ <b>DSM 24</b>  PREMIUM-Schliff / PREMIUM cut	2	3-0	0,45	schwarz/black	51523	3
	3	2-0	0,45	schwarz/black	51524	3
	2	3-0	0,75	schwarz/black	51535	3
	3	2-0	0,75	schwarz/black	51536	3
▼ <b>DS 27</b> 	3	2-0	0,45	schwarz/black	51419	3
▼ <b>DS 30</b> 	3.5	0	0,45	schwarz/black	51421	3
	3	2-0	0,75	schwarz/black	51454	3



# NYLON monofil

## Sterile Nadel-Faden-Kombination





Needle - suture - combination, sterile

Nadel / needle	Stärke Nr. gauge no.		Länge/length m	Farbe/colour	Best.-Nr. code no.	Pckg.-Inhalt box content in Dtzd./dozen
	metric	USP				
<b>1/2-Kreis schneidende Spatula, PREMIUM-Schliff = HSPM, HSPM F</b> <i>1/2 circle, spatulated, PREMIUM cut = HSPM, HSPM F</i>						
 <b>HSPM 6 F</b>	0.2	10-0	0,15	schwarz/black	51914	2
	0.3	9-0	0,15	schwarz/black	51913	2
PREMIUM-Schliff / PREMIUM cut						
 <b>2 x HSPM 6 F</b>	0.2	10-0	0,30	schwarz/black	5198	2
						
PREMIUM-Schliff / PREMIUM cut						
 <b>2 x HSPM 7</b>	0.2	10-0	0,30	schwarz/black	5193	2
	0.3	9-0	0,30	schwarz/black	5194	2
PREMIUM-Schliff / PREMIUM cut						
<b>3/8-Kreis schneidende Spatula, PREMIUM-Schliff = DSPM</b> <i>3/8 circle, spatulated, PREMIUM cut = DSPM</i>						
 <b>DSPM 4</b>	0.1	11-0	0,10	schwarz/black	52013	2
	0.2	10-0	0,10	schwarz/black	52014	2
PREMIUM-Schliff / PREMIUM cut						
 <b>DSPM 5</b>	0.2	10-0	0,30	schwarz/black	5201	2
						
PREMIUM-Schliff / PREMIUM cut						
 <b>2 x DSPM 5</b>	0.2	10-0	0,30	schwarz/black	5202	2
						
PREMIUM-Schliff / PREMIUM cut						
 <b>DSPM 6</b>	0.2	10-0	0,15	schwarz/black	5206	2
	0.3	9-0	0,15	schwarz/black	52011	2
	0.2	10-0	0,30	schwarz/black	52015	2
PREMIUM-Schliff / PREMIUM cut						
 <b>2 x DSPM 6</b>	0.2	10-0	0,30	schwarz/black	5208	2
						
PREMIUM-Schliff / PREMIUM cut						

# NYLON monofil

## Sterile Nadel-Faden-Kombination

Needle - suture - combination, sterile

Nadel / needle	Stärke Nr. gauge no.		Länge/length m	Farbe/colour	Best.-Nr. code no.	Pckg.-Inhalt box content in Dtzd./dozen
	metric	USP				
 <b>2 x DSPM 7</b>  PREMIUM-Schliff / PREMIUM cut	0.2	10-0	0,30	schwarz/black	5203	2
	0.3	9-0	0,30	schwarz/black	5204	2
<div style="background-color: #cccccc; padding: 10px; border: 1px solid #000;"> <p><b>1/4-Kreis schneidende Spatula, PREMIUM-Schliff = VSPM</b>  <i>1/4 circle, spatulated, PREMIUM cut = VSPM</i></p> </div>						
 <b>2 x VSPM 7</b>  PREMIUM-Schliff / PREMIUM cut	0.3	9-0	0,45	schwarz/black	5214	2

# NYLON monofil

Einzelfadenpackungen, steril in vorgeschrittenen Längen

*Sterile pre-cut suture, non-needed*

Stärke Nr. gauge no. metric    USP		Länge/length m	Farbe/colour	Best.-Nr. code no.	Pckg.-Inhalt box content in Dtzd./dozen
1.5	4-0	3 x 0,50	schwarz/black	X 335	2
2	3-0	3 x 0,50	schwarz/black	X 435	2
3	2-0	3 x 0,50	schwarz/black	X 535	2

## Resolon®

Resolon® (blau) ist zunächst, wie Nylon, ein monofiler, nichtabsorbierbarer Polyamidfaden, durch eine spezielle Behandlung jedoch überdurchschnittlich geschmeidig und weich. Durch die hohe Reißfestigkeit ist Resolon® selbst bei geringem Fadendurchmesser und in trockenem Zustand für feinste Nähte geeignet.

- nichtabsorbierbares Material
- überdurchschnittlich geschmeidig und weich
- sehr gute Knüpfenschaften
- hervorragender Gewebedurchzug
- keine Kapillarität
- geringe Gewebereaktion

## Resolon®









*Resolon® (blue) is, similarly to Nylon, a monofilament, non-absorbable polyamide suture, but specially treated to make it smoother and softer than average. Due to its high tensile strength - even in a dry condition - it is used for the finest sutures.*

- *non-absorbable suture*
- *softer and more supple than average*
- *perfect handling and knotting*
- *easy passage through tissue*
- *no capillarity*
- *non-irritating*

# Resolon® Polyamid

## Sterile Nadel-Faden-Kombination

















Needle - suture - combination, sterile

Nadel / needle	Stärke Nr. gauge no.		Länge/length m	Farbe/colour	Best.-Nr. code no.	Pckg.-Inhalt box content in Dtzd./dozen
	metric	USP				
<b>1/2-Kreis schneidende = HS, mit PREMIUM-Schliff = HSM</b> <i>1/2 circle, reverse cutting = HS, PREMIUM cut = HSM</i>						
▼ HS 12 	1	5-0	0,45	blau/blue	88111	3
▽ HSM 17  PREMIUM-Schliff / PREMIUM cut	1.5	4-0	0,45	blau/blue	88121	3
▼ HS 18 	1 1.5	5-0 4-0	0,45 0,45	blau/blue blau/blue	88112 88113	3 3
▼ HS 22 	2	3-0	0,45	blau/blue	88114	3
<b>3/8-Kreis schneidende = DS, mit PREMIUM-Schliff = DSM, DSM F, DSMF, DSMF X</b> <i>3/8 circle, reverse cutting = DS, PREMIUM cut = DSM, DSM F, DSMF, DSMF X</i>						
▽ DSM 7  PREMIUM-Schliff / PREMIUM cut	0.5	7-0	0,45	blau/blue	881543	3
▽ DSM 11  PREMIUM-Schliff / PREMIUM cut	0.7 1	6-0 5-0	0,45 0,45	blau/blue blau/blue	88151 88152	3 3
▽ DSM 11 F  PREMIUM-Schliff / PREMIUM cut	0.5	7-0	0,45	blau/blue	881528	3
▽ DSMF 11  PREMIUM-Schliff „fein“ / PREMIUM cut „fine“	0.7 1	6-0 5-0	0,45 0,45	blau/blue blau/blue	88221 882216	3 3
▼ DS 13 	0.7 1 1.5	6-0 5-0 4-0	0,45 0,45 0,45	blau/blue blau/blue blau/blue	881430 881431 881432	3 3 3

# Resolon® Polyamid

## Sterile Nadel-Faden-Kombination







Needle - suture - combination, sterile

Nadel / needle	Stärke Nr. gauge no.		Länge/length m	Farbe/colour	Best.-Nr. code no.	Pckg.-Inhalt box content in Dtzd./dozen
	metric	USP				
 <b>DSM 13</b>  PREMIUM-Schliff / PREMIUM cut	0.7	6-0	0,45	blau/blue	88153	3
	1	5-0	0,45	blau/blue	88154	3
	1.5	4-0	0,45	blau/blue	881523	3
 <b>DSMF 13</b>  PREMIUM-Schliff „fein“ / PREMIUM cut „fine“	0.7	6-0	0,45	blau/blue	88222	3
	1	5-0	0,45	blau/blue	88223	3
	1.5	4-0	0,45	blau/blue	882217	3
 <b>DSMFX 13</b>  PREMIUM-Schliff Spitze „fein“ / PREMIUM cut point „fine“	1	5-0	0,45	blau/blue	882221	3
	1.5	4-0	0,45	blau/blue	882228	3
 <b>DS 16</b> 	0.7	6-0	0,45	blau/blue	881440	3
	1	5-0	0,45	blau/blue	88141	3
	1.5	4-0	0,45	blau/blue	88142	3
	2	3-0	0,45	blau/blue	881433	3
	1	5-0	0,75	blau/blue	881451	3
	1.5	4-0	0,75	blau/blue	881452	3
 <b>DSM 16</b>  PREMIUM-Schliff / PREMIUM cut	0.7	6-0	0,45	blau/blue	881529	3
	1	5-0	0,45	blau/blue	88155	3
	1.5	4-0	0,45	blau/blue	88156	3
	2	3-0	0,45	blau/blue	881548	3
	1	5-0	0,75	blau/blue	881530	3
 <b>DSMF 16</b>  PREMIUM-Schliff „fein“ / PREMIUM cut „fine“	0.7	6-0	0,45	blau/blue	882210	3
	1	5-0	0,45	blau/blue	882211	3
	1.5	4-0	0,45	blau/blue	882212	3
 <b>DS 18</b> 	1	5-0	0,45	blau/blue	88143	3
	1.5	4-0	0,45	blau/blue	88144	3
	2	3-0	0,45	blau/blue	88146	3
	3	2-0	0,45	blau/blue	881454	3
	1	5-0	0,75	blau/blue	881450	3
	1.5	4-0	0,75	blau/blue	88145	3
	2	3-0	0,75	blau/blue	88147	3
	3	2-0	0,75	blau/blue	88148	3
	1.5	4-0	4 x 0,45	blau/blue	M 881421 Multipack	2
 <b>DS 18 F</b> 	1.5	4-0	0,45	blau/blue	881441	3
	1.5	4-0	0,75	blau/blue	881442	3

# Resolon® Polyamid

## Sterile Nadel-Faden-Kombination









Needle - suture - combination, sterile

Nadel / needle	Stärke Nr. gauge no.		Länge/length m	Farbe/colour	Best.-Nr. code no.	Pckg.-Inhalt box content in Dtzd./dozen
	metric	USP				
 <b>DSM 18</b> PREMIUM-Schliff / PREMIUM cut	1	5-0	0,45	blau/blue	88157	3
	1.5	4-0	0,45	blau/blue	88158	3
	2	3-0	0,45	blau/blue	881510	3
	3	2-0	0,45	blau/blue	881531	3
	1.5	4-0	0,75	blau/blue	88159	3
	2	3-0	0,75	blau/blue	881511	3
	3	2-0	0,75	blau/blue	881512	3
 <b>DSM 18 F</b> PREMIUM-Schliff / PREMIUM cut	1.5	4-0	0,45	blau/blue	881541	3
	1.5	4-0	0,75	blau/blue	881542	3
	1.5	4-0	4 x 0,45	blau/blue	M 881548 Multipack	2
 <b>DSMF 18</b> PREMIUM-Schliff „fein“ / PREMIUM cut „fine“	0.7	6-0	0,45	blau/blue	88224	3
	1	5-0	0,45	blau/blue	88225	3
	1.5	4-0	0,45	blau/blue	88226	3
	2	3-0	0,45	blau/blue	88229	3
	1.5	4-0	0,75	blau/blue	882218	3
	2	3-0	0,75	blau/blue	882219	3
 <b>DSMFX 18</b> PREMIUM-Schliff Spitze „fein“ / PREMIUM cut point „fine“	1	5-0	0,45	blau/blue	882227	3
	1.5	4-0	0,45	blau/blue	882222	3
 <b>DS 21</b>	1.5	4-0	0,45	blau/blue	88149	3
	2	3-0	0,45	blau/blue	881411	3
	1.5	4-0	0,75	blau/blue	881410	3
	2	3-0	0,75	blau/blue	881412	3
	3	2-0	0,75	blau/blue	881413	3
 <b>DSM 21</b> PREMIUM-Schliff / PREMIUM cut	1.5	4-0	0,45	blau/blue	881513	3
	2	3-0	0,45	blau/blue	881515	3
	1.5	4-0	0,75	blau/blue	881514	3
	2	3-0	0,75	blau/blue	881516	3
	3	2-0	0,75	blau/blue	881517	3
 <b>DS 24</b>	1	5-0	0,45	blau/blue	881458	3
	1.5	4-0	0,45	blau/blue	881424	3
	2	3-0	0,45	blau/blue	881414	3
	3	2-0	0,45	blau/blue	881425	3
	1.5	4-0	0,75	blau/blue	881457	3
	2	3-0	0,75	blau/blue	881415	3
	3	2-0	0,75	blau/blue	881416	3

# Resolon® Polyamid

## Sterile Nadel-Faden-Kombination

Needle - suture - combination, sterile





nadel / needle	Stärke Nr. gauge no.		Länge/length m	Farbe/colour	Best.-Nr. code no.	Pckg.-Inhalt box content in Dtzd./dozen
	metric	USP				
 <b>DSM 24</b> PREMIUM-Schliff / PREMIUM cut	1.5	4-0	0,45	blau/blue	881544	3
	2	3-0	0,45	blau/blue	881518	3
	3	2-0	0,45	blau/blue	881524	3
	1.5	4-0	0,75	blau/blue	881545	3
	2	3-0	0,75	blau/blue	881519	3
	3	2-0	0,75	blau/blue	881520	3
 <b>DSMF 24</b> PREMIUM-Schliff „fein“ / PREMIUM cut „fine“	1.5	4-0	0,45	blau/blue	882213	3
	2	3-0	0,45	blau/blue	882214	3
	3	2-0	0,45	blau/blue	882215	3
	2	3-0	0,75	blau/blue	882220	3
 <b>DSMFX 24</b> PREMIUM-Schliff Spitze „fein“ / PREMIUM cut point „fine“	2	3-0	0,45	blau/blue	882223	3
 <b>DS 27</b>	2	3-0	0,45	blau/blue	881453	3
	3	2-0	0,45	blau/blue	881423	3
	3.5	0	0,45	blau/blue	881456	3
	2	3-0	0,75	blau/blue	881417	3
	3	2-0	0,75	blau/blue	881418	3
 <b>DSM 27</b> PREMIUM-Schliff / PREMIUM cut	3	2-0	0,45	blau/blue	881525	3
	3	2-0	0,75	blau/blue	881526	3
 <b>DS 30</b>	1.5	4-0	0,45	blau/blue	881434	3
	2	3-0	0,45	blau/blue	881426	3
	3	2-0	0,45	blau/blue	881428	3
	3.5	0	0,45	blau/blue	881429	3
	1.5	4-0	0,75	blau/blue	881435	3
	2	3-0	0,75	blau/blue	881427	3
	3	2-0	0,75	blau/blue	881419	3
	3.5	0	0,75	blau/blue	881420	3
 <b>DSM 30</b> PREMIUM-Schliff / PREMIUM cut	2	3-0	0,45	blau/blue	881532	3
	3	2-0	0,45	blau/blue	881534	3
	3.5	0	0,45	blau/blue	881536	3
	2	3-0	0,75	blau/blue	881533	3
	3	2-0	0,75	blau/blue	881535	3
	3.5	0	0,75	blau/blue	881537	3
 <b>DSMFX 30</b> PREMIUM-Schliff Spitze „fein“ / PREMIUM cut point „fine“	2	3-0	0,75	blau/blue	882224	3
	3	2-0	0,75	blau/blue	882225	3



# Resolon® Polyamid

## Sterile Nadel-Faden-Kombination

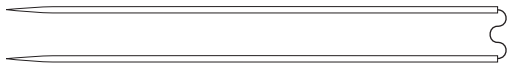
Needle - suture - combination, sterile

Nadel / needle	Stärke Nr. gauge no.		Länge/length m	Farbe/colour	Best.-Nr. code no.	Pckg.-Inhalt box content in Dtzd./dozen
	metric	USP				
<b>▼ DS 40</b> 	3	2-0	0,45	blau/blue	881436	3
	3.5	0	0,45	blau/blue	881438	3
	3	2-0	0,75	blau/blue	881437	3
	3.5	0	0,75	blau/blue	881439	3
	3	2-0	0,90	blau/blue	881455	3
<b>▽ DSM 40</b>  PREMIUM-Schliff / PREMIUM cut	3	2-0	0,75	blau/blue	881538	3
	3.5	0	0,75	blau/blue	881540	3
<b>▽ DSMFX 40</b>  PREMIUM-Schliff Spitze „fein“ / PREMIUM cut point „fine“	3	2-0	0,75	blau/blue	882226	3
<b>Gerade Rundkörper, biegsame Nadel = GRW</b> <i>Straight round bodied, flexible needle = GRW</i>						
<b>● 2 x GRW 65</b>  Biegsame Nadel / Flexible needle	3	2-0	0,75	blau/blue	88091	3
	3.5	0	0,75	blau/blue	88092	3
<b>Gerade schneidende = GS</b> <i>straight, cutting = GS</i>						
<b>▼ GS 60</b> 	2	3-0	0,75	blau/blue	88171	3
	3	2-0	0,75	blau/blue	88172	3

# Resolon® Polyamid

Einzelfadenpackungen, steril in vorgeschrittenen Längen

*Sterile pre-cut suture, non-needed*

Stärke Nr. gauge no. metric    USP		Länge/length m	Farbe/colour	Best.-Nr. code no.	Pckg.-Inhalt box content in Dtzd./dozen
1.5	4-0	3 x 0,50	blau/blue	X 335 N	2
2	3-0	3 x 0,50	blau/blue	X 435 N	2
3	2-0	3 x 0,50	blau/blue	X 535 N	2
3.5	0	3 x 0,50	blau/blue	X 635 N	2
2	3-0	10 x 0,50	blau/blue	X 4105 N	2

## Supramid® extra

Nichtabsorbierbares Supramid®, ein Fadenmaterial aus Polyamid, liegt bei kleineren Fadendurchmessern als Monofilament vor. Ab der Stärke 1.5 EP / 4-0 USP ist die Struktur von Supramid® ein Bündel feinsten Fasern umhüllt mit einem schlauchartigen Polyamid-Mantel. Diese Struktur ist für die besonderen Eigenschaften einer glatten Oberfläche in Kombination mit der hohen Geschmeidigkeit und Festigkeit eines multifilen Fadens verantwortlich. Supramid® wird in den Farben weiß und schwarz angeboten,

- nicht absorbierbarer Polyamid-Faden
- sehr geschmeidig
- zugfest
- geringe Gewebereaktion
- gute Knüpfbarkeit

## Supramid® extra









*Non-absorbable Supramid® is a monofilament in small diameters (polyamide). From 1.5 EP / 4-0 USP, the special structure of Supramid® is made by coating numerous fibres with polyamide to form a single thread. This structure combines the advantages of a smooth thread's surface with high pliability and strength of the multifilament. Supramid® is available in black and white.*

- non-absorbable polyamide-suture
- very soft
- high tensile strength
- less tissue reaction
- good knotting properties

# Supramid® extra Polyamid

## Sterile Nadel-Faden-Kombination







Needle - suture - combination, sterile

Nadel / needle	Stärke Nr. gauge no.		Länge/length m	Farbe/colour	Best.-Nr. code no.	Pckg.-Inhalt box content in Dtzd./dozen
	metric	USP				
<b>1/2-Kreis schneidende Rundkörper = HRT</b> <i>1/2 circle, round bodied, trocar point = HRT</i>						
<b>▼ HRT 18</b> 	1.5	4-0	0,50	schwarz/black	6061	3
	2	3-0	0,50	schwarz/black	6062	3
	1.5	4-0	0,75	schwarz/black	6063	3
	2	3-0	0,75	schwarz/black	6064	3
<b>1/2-Kreis schneidende = HS</b> <i>1/2 circle, reverse cutting = HS</i>						
<b>▼ HS 18</b> 	1	5-0	0,45	schwarz/black	6111	3
	1.5	4-0	0,45	schwarz/black	6112	3
	2	3-0	0,45	schwarz/black	6114	3
	2	3-0	0,75	schwarz/black	6117	3
<b>▼ HS 20</b> 	2	3-0	0,75	schwarz/black	6116	3
<b>▼ HS 22</b> 	2	3-0	0,45	schwarz/black	6113	3
	3	2-0	0,75	schwarz/black	6115	3
<b>3/8-Kreis schneidende = DS, DS F mit PREMIUM-Schliff = DSM</b> <i>3/8 circle, reverse cutting = DS, DS F PREMIUM cut = DSM</i>						
<b>▽ DSM 11</b>  PREMIUM-Schliff / PREMIUM cut	0.7	6-0	0,45	schwarz/black	6151	3
	1	5-0	0,45	schwarz/black	6152	3
<b>▼ DS 13</b> 	1	5-0	0,45	schwarz/black	6141	3
<b>▽ DSM 13</b>  PREMIUM-Schliff / PREMIUM cut	1.5	4-0	0,45	schwarz/black	6154	3
<b>▽ DSM 16</b>  PREMIUM-Schliff / PREMIUM cut	1.5	4-0	0,75	schwarz/black	6153	3

# Supramid® extra Polyamid

## Sterile Nadel-Faden-Kombination

Needle - suture - combination, sterile

Nadel / needle	Stärke Nr. gauge no.		Länge/length m	Farbe/colour	Best.-Nr. code no.	Pckg.-Inhalt box content in Dtzd./dozen
	metric	USP				
▼ DS 18 	1.5	4-0	0,45	schwarz/black	6142	3
	2	3-0	0,45	schwarz/black	6143	3
	2	3-0	6 x 0,45	schwarz/black	M 6144 Multipack	1
▼ DS 18 F 	1.5	4-0	0,45	schwarz/black	61420	3
▼ DS 24 	1.5	4-0	0,45	schwarz/black	6146	3
	2	3-0	0,45	schwarz/black	6147	3
	3	2-0	0,45	schwarz/black	61422	3
	2	3-0	0,75	schwarz/black	61425	3
	2	3-0	6 x 0,45	schwarz/black	M 6148 Multipack	1
	3	2-0	0,45	schwarz/black	6149	3
▼ DS 30 	3.5	0	0,45	schwarz/black	61423	3
	3	2-0	0,75	schwarz/black	61426	3
	3.5	0	0,75	schwarz/black	61427	3
	3	2-0	6 x 0,45	schwarz/black	M 61411 Multipack	1
	2	3-0	0,45	schwarz/black	61412	3
	2.5	2-0	0,45	schwarz/black	61413	3
▼ DS 40 	3.5	0	0,75	weiß/white	61421	3
	<div style="background-color: #cccccc; padding: 5px;"> <p><b>1/4-Kreis schneidende Spatula, PREMIUM-Schliff = VSPM, VSPM F</b> 1/4 circle, spatulated, PREMIUM cut = VSPM, VSPM F</p> </div>					
	1.5	4-0	0,75	weiß/white	6211	2
▽ VSPM 8  PREMIUM-Schliff / PREMIUM cut	1.5	4-0	0,25	weiß/white	6213	2
	1.5	4-0	0,45	weiß/white	6214	2
▽ 2x VSPM 8  PREMIUM-Schliff / PREMIUM cut	1	5-0	0,45	weiß/white	6212	2
	PREMIUM-Schliff / PREMIUM cut					

# Supramid® extra Polyamid

## Einzelfadenpackungen, steril in vorgeschrittenen Längen

*Sterile pre-cut suture, non-neededled*

Stärke Nr. gauge no.		Länge/length m	Farbe/colour	Best.-Nr. code no.	Pckg.-Inhalt box content in Dtzd./dozen
metric	USP				
1.5	4-0	3 x 0,50	schwarz/black	SAM 335	2
2	3-0	3 x 0,50	schwarz/black	SAM 435	2
3	2-0	3 x 0,50	schwarz/black	SAM 535	2
3.5	0	3 x 0,50	schwarz/black	SAM 635	2
4	1	3 x 0,50	schwarz/black	SAM 735	2
1.5	4-0	3 x 0,50	weiß/white	M 335	2
2	3-0	3 x 0,50	weiß/white	M 435	2
3	2-0	3 x 0,50	weiß/white	M 535	2
3.5	0	3 x 0,50	weiß/white	M 635	2
4	1	3 x 0,50	weiß/white	M 735	2
1.5	4-0	5 x 0,50	schwarz/black	SAM 355	2
2	3-0	5 x 0,50	schwarz/black	SAM 455	2
3	2-0	5 x 0,50	schwarz/black	SAM 555	2
3.5	0	5 x 0,50	schwarz/black	SAM 655	2
2	3-0	5 x 0,50	weiß/white	M 455	2
3	2-0	5 x 0,50	weiß/white	M 555	2
3.5	0	5 x 0,50	weiß/white	M 655	2
2	3-0	10 x 0,50	schwarz/black	SAM 4105	2
2	3-0	10 x 0,50	weiß/white	M 4105	2
3	2-0	10 x 0,50	weiß/white	M 5105	2

## Seide "E"

Das Nahtmaterial wird aus dem Kokon der Seidenspinnerraupe gewonnen und durch einen speziellen Prozess zur qualitativ hochwertigen geflochtenen Seide "E" verarbeitet. Es ist in den Farben schwarz und weiß lieferbar, als gezwirntes Material in der Farbe blau.

- nichtabsorbierbarer Seidenfaden
- hohe Geschmeidigkeit
- hervorragendes Knüpfverhalten
- maximale Zugfestigkeit
- nichtkapillar und wasserabstoßend
- glatte Oberfläche

## Silk "E"









*This suture is made of continuous fibres from silkworm cocoons, and is processed into braided and purified Silk "E" of prime quality. It is available in black and white, twisted Silk "E" is dyed blue.*

- *non-absorbable suture*
- *permanent pliability*
- *perfect knot security*
- *maximum tensile strength*
- *non-capillary and water-repellent*
- *smooth surface*

# Seide "E"

## Sterile Nadel-Faden-Kombination

Needle - suture - combination, sterile





Nadel / needle	Stärke Nr. gauge no.		Länge/length m	Farbe/colour	Best.-Nr. code no.	Pckg.-Inhalt box content in Dtzd./dozen
	metric	USP				
<b>1/2-Kreis Rundkörper = HR, HRS</b> <i>1/2 circle, round bodied = HR, HRS</i>						
● HR 10 	1	5-0	0,45	schwarz, geflochten <i>black, braided</i>	4021	3
● HR 12 	1	5-0	0,45	schwarz, geflochten <i>black, braided</i>	4023	3
	1.5	4-0	0,45	schwarz, geflochten <i>black, braided</i>	4024	3
● HR 12 A  Abziehnadel/ <i>control release needle</i>	1.5	4-0	8 x 0,45	schwarz, geflochten <i>black, braided</i>	A 40248 Multipack	1
	2	3-0	8 x 0,45	schwarz, geflochten <i>black, braided</i>	A 40264 Multipack	1
● HR 17 	1	5-0	0,75	schwarz, geflochten <i>black, braided</i>	4026	3
	1.5	4-0	0,75	schwarz, geflochten <i>black, braided</i>	4027	3
	2	3-0	0,45	schwarz, geflochten <i>black, braided</i>	40267	3
	2	3-0	0,75	schwarz, geflochten <i>black, braided</i>	4028	3
	3	2-0	0,75	schwarz, geflochten <i>black, braided</i>	4029	3
● HR 17 A  Abziehnadel/ <i>control release needle</i>	1.5	4-0	8 x 0,45	schwarz, geflochten <i>black, braided</i>	A 40249 Multipack	1
	2	3-0	8 x 0,45	schwarz, geflochten <i>black, braided</i>	A 40250 Multipack	1
	3	2-0	8 x 0,45	schwarz, geflochten <i>black, braided</i>	A 40265 Multipack	1
● 2 x HR 17 	1.5	4-0	0,75	schwarz, geflochten <i>black, braided</i>	40215	3
	2	3-0	0,75	schwarz, geflochten <i>black, braided</i>	40216	3
● HR 22 	1.5	4-0	0,75	schwarz, geflochten <i>black, braided</i>	40219	3
	2	3-0	0,75	schwarz, geflochten <i>black, braided</i>	40220	3
	3	2-0	0,75	schwarz, geflochten <i>black, braided</i>	40221	3
● HR 22 A  Abziehnadel/ <i>control release needle</i>	2	3-0	8 x 0,45	schwarz, geflochten <i>black, braided</i>	A 40252 Multipack	1
	3	2-0	8 x 0,45	schwarz, geflochten <i>black, braided</i>	A 40253 Multipack	1



# Seide "E"

## Sterile Nadel-Faden-Kombination







Needle - suture - combination, sterile

Nadel / needle	Stärke Nr. gauge no.		Länge/length m	Farbe/colour	Best.-Nr. code no.	Pckg.-Inhalt box content in Dtzd./dozen
	metric	USP				
<b>● HR 27</b> 	2	3-0	0,75	schwarz, geflochten <i>black, braided</i>	40226	3
	3	2-0	0,75	schwarz, geflochten <i>black, braided</i>	40227	3
	3.5	0	0,75	schwarz, geflochten <i>black, braided</i>	40228	3
	4	1	0,75	schwarz, geflochten <i>black, braided</i>	40229	3
	3	2-0	6 x 0,75	schwarz, geflochten <i>black, braided</i>	M 40233 Multipack	1
<b>● HR 30</b> 	3	2-0	0,75	schwarz, geflochten <i>black, braided</i>	40238	3
	3.5	0	0,75	schwarz, geflochten <i>black, braided</i>	40239	3
<b>● HR 35</b> 	3	2-0	0,75	schwarz, geflochten <i>black, braided</i>	40242	3
	3.5	0	0,75	schwarz, geflochten <i>black, braided</i>	40243	3
	4	1	0,75	schwarz, geflochten <i>black, braided</i>	40244	3
	5	2	0,75	schwarz, geflochten <i>black, braided</i>	40245	3
<b>● HRS 35</b> 	3.5	0	0,75	schwarz, geflochten <i>black, braided</i>	4031	3
<b>● HR 40</b> 	4	1	0,75	schwarz, geflochten <i>black, braided</i>	40247	3

# Seide "E"

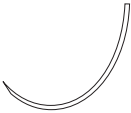
## Sterile Nadel-Faden-Kombination









Needle - suture - combination, sterile

Nadel / needle	Stärke Nr. gauge no.		Länge/length m	Farbe/colour	Best.-Nr. code no.	Pckg.-Inhalt box content in Dtzd./dozen
	metric	USP				
<b>1/2-Kreis schneidende Rundkörper = HRT</b> <i>1/2 circle, round bodied, trocar point = HRT</i>						
<b>▼ HRT 18</b> 	1.5	4-0	0,45	schwarz, geflochten <i>black, braided</i>	40616	3
	2	3-0	0,45	schwarz, geflochten <i>black, braided</i>	40615	3
	3	2-0	0,45	schwarz, geflochten <i>black, braided</i>	40617	3
	2	3-0	6 x 0,45	schwarz, geflochten <i>black, braided</i>	M 40618 Multipack	1
	1.5	4-0	0,75	schwarz, geflochten <i>black, braided</i>	4062	3
	2	3-0	0,75	schwarz, geflochten <i>black, braided</i>	4063	3
	3	2-0	0,75	schwarz, geflochten <i>black, braided</i>	4064	3
	<b>▼ HRT 25</b> 	2	3-0	0,75	schwarz, geflochten <i>black, braided</i>	40610
3		2-0	0,75	schwarz, geflochten <i>black, braided</i>	40611	3
<b>Asymptotische schneidende Rundkörper = ART</b> <i>Asymptotic, round bodied, trocar point = ART</i>						
<b>▼ ART 13</b> 	1.5	4-0	0,45	schwarz, geflochten <i>black, braided</i>	4281	1
	<b>▼ ART 25</b> 	1.5	4-0	0,45	schwarz, geflochten <i>black, braided</i>	4282
2		3-0	0,45	schwarz, geflochten <i>black, braided</i>	4283	1
<b>3/8-Kreis Rundkörper = DR, DR F</b> <i>3/8 circle, round bodied = DR, DR F</i>						
<b>● DR 10 F</b> 	0.5	7-0	0,30	schwarz, geflochten <i>black, braided</i>	4071	2
	0.7	6-0	0,45	schwarz, geflochten <i>black, braided</i>	4072	2
<b>● DR 12</b> 	1	5-0	0,75	schwarz, geflochten <i>black, braided</i>	4078	3
	1.5	4-0	0,75	schwarz, geflochten <i>black, braided</i>	4079	3
<b>● 2 x DR 12</b> 	1	5-0	0,45	schwarz, geflochten <i>black, braided</i>	40712	3

# Seide "E"

## Sterile Nadel-Faden-Kombination









Needle - suture - combination, sterile

Nadel / needle	Stärke Nr. gauge no.		Länge/length m	Farbe/colour	Best.-Nr. code no.	Pckg.-Inhalt box content in Dtzd./dozen
	metric	USP				
 <b>DR 12 F</b>	0.7	6-0	0,45	schwarz, geflochten black, braided	4077	3
 <b>DR 18</b>	2	3-0	0,30	schwarz, geflochten black, braided	40725	3
<b>3/8-Kreis Rundkörper stumpf</b> <i>3/8 circle, round bodied, blunt point</i>						
 <b>DRN 17</b>	2	3-0	0,30	schwarz, geflochten black, braided	4273	3
	2	3-0	2 x 0,75	schwarz, geflochten black, braided	M 4272 Multipack	2
<b>3/8-Kreis schneidende Rundkörper = DRT</b> <i>3/8 circle, round bodied, trocar point = DRT</i>						
 <b>DRT 18</b>	2	3-0	0,75	schwarz, geflochten black, braided	4083	3
<b>Gerade Rundkörper = GR</b> <i>Straight round bodied = GR</i>						
 <b>GR 20</b>	1.5	4-0	0,45	schwarz, geflochten black, braided	40918	3
	1.5	4-0	0,75	schwarz, geflochten black, braided	4091	3
 <b>GR 45</b>	2	3-0	0,75	schwarz, geflochten black, braided	4095	3
<b>1/2-Kreis schneidende = HS mit PREMIUM-Schliff = HSM, HSM S</b> <i>1/2 circle, reverse cutting = HS PREMIUM cut = HSM, HSM S</i>						
 <b>2 x HSM 9 S</b> <small>PREMIUM-Schliff   PREMIUM cut</small>	1.5	4-0	0,45	schwarz, geflochten black, braided	4125	2
 <b>2 x HSM 10</b> <small>PREMIUM-Schliff   PREMIUM cut</small>	0.7	6-0	0,45	schwarz, geflochten black, braided	4130	2
 <b>HS 12</b>	1	5-0	0,45	schwarz, geflochten black, braided	4111	3

# Seide "E"

## Sterile Nadel-Faden-Kombination









Needle - suture - combination, sterile

Nadel / needle	Stärke Nr. gauge no.		Länge/length m	Farbe/colour	Best.-Nr. code no.	Pckg.-Inhalt box content in Dtzd./dozen
	metric	USP				
▽ <b>HSM 13</b>	1	5-0	0,45	schwarz, geflochten <i>black, braided</i>	41210	3
 PREMIUM-Schliff / <i>PREMIUM cut</i>	1.5	4-0	0,45	schwarz, geflochten <i>black, braided</i>	41211	3
▼ <b>HS 18</b>	1.5	4-0	0,45	schwarz, geflochten <i>black, braided</i>	4112	3
	2	3-0	0,45	schwarz, geflochten <i>black, braided</i>	4113	3
▼ <b>HS 22</b>	2	3-0	0,45	schwarz, geflochten <i>black, braided</i>	4116	3
	3	2-0	0,45	schwarz, geflochten <i>black, braided</i>	4117	3
▼ <b>HS 35</b>	3	2-0	0,75	schwarz, geflochten <i>black, braided</i>	41110	3
						
<p><b>3/8-Kreis schneidende = DS mit PREMIUM-Schliff = DSM, DSM F</b>  <i>3/8 circle, reverse cutting = DS            PREMIUM cut = DSM, DSM F</i></p>						
▽ <b>DSM 6</b>	0.4	8-0	0,30	blau, gedreht <i>blue, twisted</i>	4154	2
 PREMIUM-Schliff / <i>PREMIUM cut</i>						
▽ <b>DSM 7 F</b>	0.5	7-0	0,30	schwarz, geflochten <i>black, braided</i>	4157	2
 PREMIUM-Schliff / <i>PREMIUM cut</i>	0.7	6-0	0,30	schwarz, geflochten <i>black, braided</i>	4158	2
▽ <b>2 x DSM 7 F</b>	0.5	7-0	0,45	schwarz, geflochten <i>black, braided</i>	4159	2
 PREMIUM-Schliff / <i>PREMIUM cut</i>	0.7	6-0	0,45	schwarz, geflochten <i>black, braided</i>	41510	2
▽ <b>DSM 11</b>	0.7	6-0	0,45	schwarz, geflochten <i>black, braided</i>	41517	3
 PREMIUM-Schliff / <i>PREMIUM cut</i>						
▽ <b>DSM 11 F</b>	0.7	6-0	0,45	schwarz, geflochten <i>black, braided</i>	41538	3
 PREMIUM-Schliff / <i>PREMIUM cut</i>						

# Seide "E"

## Sterile Nadel-Faden-Kombination







Needle - suture - combination, sterile

Nadel / needle	Stärke Nr. gauge no.		Länge/length m	Farbe/colour	Best.-Nr. code no.	Pckg.-Inhalt box content in Dtzd./dozen
	metric	USP				
<b>▽ 2 x DSM 11 F</b>  PREMIUM-Schliff / PREMIUM cut	0.7	6-0	0,45	schwarz, geflochten black, braided	41519	3
<b>▼ DS 13</b> 	0.7	6-0	0,35	schwarz, geflochten black, braided	4141	3
	1	5-0	0,45	schwarz, geflochten black, braided	4142	3
	1.5	4-0	0,45	schwarz, geflochten black, braided	4143	3
<b>▼ 2 x DS 13</b> 	1	5-0	0,35	schwarz, geflochten black, braided	4145	3
	1.5	4-0	0,35	schwarz, geflochten black, braided	4146	3
	0.7	6-0	0,45	schwarz, geflochten black, braided	4144	3
<b>▽ DSM 13</b>  PREMIUM-Schliff / PREMIUM cut	0.7	6-0	0,45	schwarz, geflochten black, braided	41542	3
	1	5-0	0,45	schwarz, geflochten black, braided	41520	3
	1.5	4-0	0,45	schwarz, geflochten black, braided	41521	3
<b>▽ DSM 13 S</b>  PREMIUM-Schliff / PREMIUM cut	1.5	4-0	0,45	schwarz, geflochten black, braided	41522	3
<b>▼ DS 16</b> 	0.7	6-0	0,45	schwarz, geflochten black, braided	4147	3
	1	5-0	0,45	schwarz, geflochten black, braided	4148	3
	1.5	4-0	0,45	schwarz, geflochten black, braided	4149	3
<b>▽ DSM 16</b>  PREMIUM-Schliff / PREMIUM cut	1	5-0	0,45	schwarz, geflochten black, braided	41524	3
	1.5	4-0	0,45	schwarz, geflochten black, braided	41525	3
<b>▼ DS 18</b> 	1	5-0	0,45	schwarz, geflochten black, braided	41411	3
	1.5	4-0	0,45	schwarz, geflochten black, braided	41412	3
	2	3-0	0,45	schwarz, geflochten black, braided	41413	3

# Seide "E"

## Sterile Nadel-Faden-Kombination









Needle - suture - combination, sterile

Nadel / needle	Stärke Nr. gauge no.		Länge/length m	Farbe/colour	Best.-Nr. code no.	Pckg.-Inhalt box content in Dtzd./dozen
	metric	USP				
 <b>DSM 18</b> PREMIUM-Schliff / PREMIUM cut	1.5	4-0	0,45	schwarz, geflochten <i>black, braided</i>	41527	3
	2	3-0	0,45	schwarz, geflochten <i>black, braided</i>	41528	3
	3	2-0	0,45	schwarz, geflochten <i>black, braided</i>	41529	3
 <b>DS 21</b>	1.5	4-0	0,45	schwarz, geflochten <i>black, braided</i>	41431	3
	2	3-0	0,45	schwarz, geflochten <i>black, braided</i>	41432	3
	3	2-0	0,45	schwarz, geflochten <i>black, braided</i>	41433	3
 <b>DSM 21</b> PREMIUM-Schliff / PREMIUM cut	2	3-0	0,45	schwarz, geflochten <i>black, braided</i>	41535	3
	3	2-0	0,45	schwarz, geflochten <i>black, braided</i>	41536	3
 <b>DS 24</b>	1.5	4-0	0,45	schwarz, geflochten <i>black, braided</i>	41416	3
	2	3-0	0,45	schwarz, geflochten <i>black, braided</i>	41417	3
	3	2-0	0,45	schwarz, geflochten <i>black, braided</i>	41418	3
	2	3-0	0,75	schwarz, geflochten <i>black, braided</i>	41419	3
	3	2-0	0,75	schwarz, geflochten <i>black, braided</i>	41436	3
 <b>DSM 24</b> PREMIUM-Schliff / PREMIUM cut	3	2-0	0,45	schwarz, geflochten <i>black, braided</i>	41533	3
	3	2-0	0,45	schwarz, geflochten <i>black, braided</i>	41531	3
 <b>DS 27</b>	3	2-0	0,45	schwarz, geflochten <i>black, braided</i>	41422	3
 <b>DS 30</b>	2	3-0	0,45	schwarz, geflochten <i>black, braided</i>	41423	3
	3	2-0	0,45	schwarz, geflochten <i>black, braided</i>	41424	3
	3.5	0	0,45	schwarz, geflochten <i>black, braided</i>	41425	3
	3	2-0	0,75	schwarz, geflochten <i>black, braided</i>	41426	3
	3.5	0	0,75	schwarz, geflochten <i>black, braided</i>	41428	3

# Seide "E"

## Sterile Nadel-Faden-Kombination







Needle - suture - combination, sterile

Nadel / needle	Stärke Nr. gauge no.		Länge/length m	Farbe/colour	Best.-Nr. code no.	Pckg.-Inhalt box content in Dtzd./dozen
	metric	USP				
<b>▼ DS 40</b> 	3.5	0	0,75	schwarz, geflochten black, braided	41430	3
	4	1	0,75	schwarz, geflochten black, braided	41437	3
<b>Gerade schneidende = GS</b> <i>Straight, cutting = GS</i>						
<b>▼ GS 60</b> 	3	2-0	0,75	schwarz, geflochten black, braided	4170	3
<b>1/2-Kreis gebogene schneidende = KS</b> <i>1/2 circle, curved reverse cutting = KS</i>						
<b>▼ KS 20</b> 	2	3-0	0,45	schwarz, geflochten black, braided	4181	3
<b>1/2-Kreis schneidende Spatula, PREMIUM-Schliff = HSPM, HSPM F</b> <i>1/2 circle, spatulated, PREMIUM cut = HSPM, HSPM F</i>						
<b>▽ 2 x HSPM 6 F</b>  PREMIUM-Schliff   PREMIUM cut	0.4	8-0	0,30	blau, gedreht blue, twisted	4195	2
<b>▽ 2 x HSPM 8</b>  PREMIUM-Schliff   PREMIUM cut	0.7	6-0	0,45	weiß, geflochten white, braided	4191	2
<b>3/8-Kreis schneidende Spatula, PREMIUM-Schliff = DSPM</b> <i>3/8 circle, spatulated, PREMIUM cut = DSPM</i>						
<b>▽ DSPM 5</b>  PREMIUM-Schliff   PREMIUM cut	0.4	8-0	0,30	blau, gedreht blue, twisted	4202	2
<b>▽ 2 x DSPM 5</b>  PREMIUM-Schliff   PREMIUM cut	0.4	8-0	0,30	blau, gedreht blue, twisted	4206	2
<b>▽ 2 x DSPM 6</b>  PREMIUM-Schliff   PREMIUM cut	0.4	8-0	0,30	blau, gedreht blue, twisted	42011	2
	0.3	9-0	0,45	blau, gedreht blue, twisted	42017	2

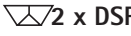
# Seide "E"

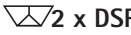
## Sterile Nadel-Faden-Kombination

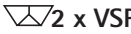
Needle - suture - combination, sterile

Nadel / needle	Stärke Nr. gauge no.		Länge/length m	Farbe/colour	Best.-Nr. code no.	Pckg.-Inhalt box content in Dtzd./dozen
	metric	USP				
 <b>2 x DSPM 7</b>	0.4	8-0	0,45	schwarz, geflochten <i>black, braided</i>	42015	2
 PREMIUM-Schliff / <i>PREMIUM cut</i>	0.4	8-0	0,45	blau, gedreht <i>black, braided</i>	42024	2
	0.5	7-0	0,45	schwarz, geflochten <i>black, braided</i>	42021	2
 <b>2 x DSPM 8</b>	0.7	6-0	0,45	schwarz, geflochten <i>black, braided</i>	4208	2
 PREMIUM-Schliff / <i>PREMIUM cut</i>						
<b>1/4-Kreis schneidende Spatula, PREMIUM-Schliff = VSPM F</b> <i>1/4 circle, spatulated, PREMIUM cut = VSPM F</i>						
 <b>2 x VSPM 8 F</b>	0.7	6-0	0,45	schwarz, geflochten <i>black, braided</i>	4217	2
 PREMIUM-Schliff / <i>PREMIUM cut</i>	1	5-0	0,45	schwarz, geflochten <i>black, braided</i>	4218	2



# Seide "E"

Einzelfadenpackungen, steril in vorgeschnittenen Längen

Sterile pre-cut suture, non-needed

Stärke Nr. gauge no. metric		USP	Länge/length m	Farbe/colour	Best.-Nr. code no.	Pckg.-Inhalt box content in Dtzd./dozen
1.5	4-0		5 x 0,35	schwarz/black	G 353	2
2	3-0		5 x 0,35	schwarz/black	G 453	2
3	2-0		5 x 0,35	schwarz/black	G 553	2
1.5	4-0		3 x 0,50	schwarz/black	G 335	2
2	3-0		3 x 0,50	schwarz/black	G 435	2
3	2-0		3 x 0,50	schwarz/black	G 535	2
3.5	0		3 x 0,50	schwarz/black	G 635	2
4	1		3 x 0,50	schwarz/black	G 735	2
5	2		3 x 0,50	schwarz/black	G 835	2
3.5	0		3 x 0,50	weiß/white	WG 635	2
4	1		3 x 0,50	weiß/white	WG 735	2
1.5	4-0		5 x 0,50	schwarz/black	G 355	2
2	3-0		5 x 0,50	schwarz/black	G 455	2
3	2-0		5 x 0,50	schwarz/black	G 555	2
3.5	0		5 x 0,50	schwarz/black	G 655	2
4	1		5 x 0,50	schwarz/black	G 755	2
5	2		5 x 0,50	schwarz/black	G 855	2
6	3		5 x 0,50	schwarz/black	G 955	2
3	2-0		5 x 0,50	weiß/white	WG 555	2
3.5	0		5 x 0,50	weiß/white	WG 655	2
2	3-0		6 x 0,50	schwarz/black	SG 455	2
3	2-0		6 x 0,50	schwarz/black	SG 555	2
3.5	0		6 x 0,50	schwarz/black	SG 655	2
4	1		6 x 0,50	schwarz/black	SG 755	2
5	2		6 x 0,50	schwarz/black	SG 855	2
5	2		6 x 0,50	weiß/white	WSG 855	2
1	5-0		10 x 0,50	schwarz/black	G 2105	2
1.5	4-0		10 x 0,50	schwarz/black	G 3105	2
2	3-0		10 x 0,50	schwarz/black	G 4105	2
3	2-0		10 x 0,50	schwarz/black	G 5105	2
3.5	0		10 x 0,50	schwarz/black	G 6105	2
4	1		10 x 0,50	schwarz/black	G 7105	2
3.5	0		12 x 0,50	weiß/white	WSG 6105	2
5	2		12 x 0,50	weiß/white	WSG 8105	2
3	2-0		2 x 0,75	schwarz/black	G 520	2
3.5	0		2 x 0,75	schwarz/black	G 620	2
4	1		2 x 0,75	schwarz/black	G 720	2
5	2		2 x 0,75	schwarz/black	G 820	2
6	3		2 x 0,75	schwarz/black	G 920	2
7	5		2 x 0,75	schwarz/black	G 1020	2
4	1		2 x 0,75	weiß/white	WG 720	2
5	2		2 x 0,75	weiß/white	WG 820	2
6	3		2 x 0,75	weiß/white	WG 920	2

# Seide "E"

Einzelfadenpackungen, steril in vorgeschrittenen Längen

*Sterile pre-cut suture, non-needled*

Stärke Nr. gauge no.		Länge/length m	Farbe/colour	Best.-Nr. code no.	Pckg.-Inhalt box content in Dtzd./dozen
metric	USP				
2	3-0	5 x 0,75	schwarz/black	G 450	2
3	2-0	5 x 0,75	schwarz/black	G 550	2
3.5	0	5 x 0,75	schwarz/black	G 650	2
4	1	5 x 0,75	schwarz/black	G 750	2
5	2	5 x 0,75	schwarz/black	G 850	2
2	3-0	1 x 1,40	schwarz/black	SG 411	2
3	2-0	1 x 1,40	schwarz/black	SG 511	2
7	5	1 x 1,40	schwarz/black	SG 1011	2

# Stahldraht

Stahldraht-Nahtmaterial wird aus nichtrostenden, korrosionsbeständigen Stahllegierungen hergestellt.

- nichtabsorbierbarer Stahldraht
- monofil oder polyfil
- hohe Zugfestigkeit
- sehr gewebefreundlich
- keine Dehnung

## *Surgical Steel*





*Steelwire is made of corrosion-resistant, stainless steel alloy.*

- *non-absorbable steel wire*
- *available as monofilament or multifilament*
- *high tensile strength*
- *completely non-irritating*
- *non-stretch*

# STAHLDRAHT

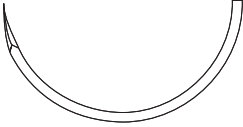
## Sterile Nadel-Faden-Kombination

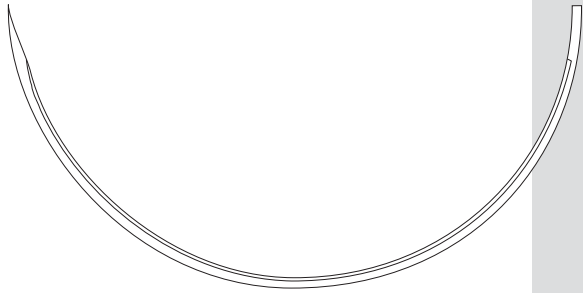
Needle - suture - combination, sterile

Nadel / needle	Stärke Nr. gauge no.		Länge/length m	Art/sort	Best.-Nr. code no.	Pckg.-Inhalt box content in Dtzd./dozen
	metric	USP				
<b>1/2-Kreis schneidende Rundkörper = HRTX</b> <i>1/2 circle, trocar point, round bodied = HRTX</i>						
<b>▼ HRTX 50</b>  Sternum-Naht / Sternum-Suture	7	5	4 x 0,45	monofil	L 99063 Multi-L-Pack	1
	8	6	4 x 0,45	monofil	L 99064 Multi-L-Pack	1
	9	7	4 x 0,45	monofil	L 99065 Multi-L-Pack	1
	7	5	6 x 0,45	monofil	L 99066 Multi-L-Pack	1
	8	6	6 x 0,45	monofil	L 99067 Multi-L-Pack	1
<b>1/2-Kreis schneidende = HS</b> <i>1/2 circle, reverse-cutting = HS</i>						
<b>▼ HS 35</b> 	3	2-0	0,60	monofil	99112	3
<b>▼ HS 120</b>  Patella-Naht / Patella-Suture Set	6	3	0,60	monofil	99115	1/2
<b>3/8-Kreis schneidende = DS mit PREMIUM-Schliff = DSM</b> <i>3/8 circle, reverse cutting = DS PREMIUM cut = DSM</i>						
<b>▽ DSM 13</b>  PREMIUM-Schliff / PREMIUM cut	1	5-0	0,45	monofil	99157	3
	1.5	4-0	0,45	monofil	99158	3
<b>▼ DS 18</b> 	1	5-0	0,45	monofil	99144	3
	1.5	4-0	0,45	monofil	99145	3

# STAHLDRAHT

## Sterile Nadel-Faden-Kombination

Needle - suture - combination, sterile

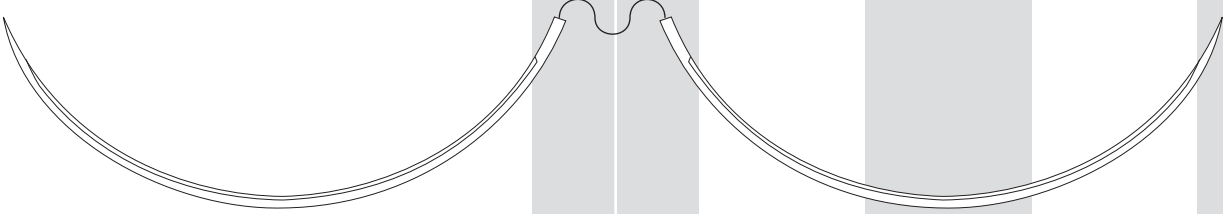
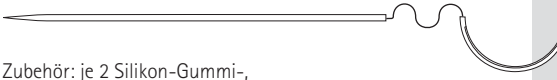
Nadel / needle	Stärke Nr. gauge no.		Länge/length m	Art/sort	Best.-Nr. code no.	Pckg.-Inhalt box content in Dtzd./dozen		
	metric	USP						
<b>Einfache Unterstützungsnaht</b> <i>Tension suture</i>								
	5	2	0,45	polyfil	991411U	1/4		
	5	2	0,45	polyfil	S 991411	1/4		
	6	3	0,45	polyfil	S 991412	1/4		
				Polyethylenbeschichtet <i>Coated with Polyethylene</i>				
				Polyethylenbeschichtet <i>Coated with Polyethylene</i>				
Zubehör: je 2 Moosgummiplatten ø 35 mm, Polyesterscheiben ø 30 mm und 4 Bleiplomben (2 fest, 2 lose) <i>Incl. accessories</i>								
<b>Doppelte Unterstützungsnaht</b> <i>Double-armed Tension suture</i>								
<b>▼ 2 x DS 90</b>								
	5	2	0,75	polyfil	991413 U	1/2		
	6	3	0,75	polyfil	991414 U	1/2		
	5	2	0,90	polyfil	S 991413	1/2		
	6	3	0,90	polyfil	S 991414	1/2		
				Polyethylenbeschichtet <i>Coated with Polyethylene</i>				
				Polyethylenbeschichtet <i>Coated with Polyethylene</i>				
Zubehör: je 2 Nylonplatten 80 x 23 mm und Moosgummiplatten 82 x 25 mm <i>Incl. accessories</i>								
<b>Sehnen-Nähte</b> <i>Tendon Suture</i>								
<b>Sehnen-Naht nach LENGEMANN mit Widerhaken</b> <i>LENGEMANN's Tendon Suture with barb</i>								
	● GR 51	▼ HS 22	2	3-0	0,35	polyfil	LE 99092	1
			3	2-0	0,35	polyfil	LE 99093	1
Zubehör: je 2 Silikon-Gummi-, Polyesterscheiben (1 Loch) und Aluplomben <i>Incl. 4 buttons</i>								



# STAHLDRAHT

**Einzelfadenpackungen, steril in vorgeschnittenen Längen**

*Sterile pre-cut suture, non-needled*

Stärke Nr. gauge no. metric    USP		Länge/length m	Art/sort	Best.-Nr. code no.	Pckg.-Inhalt box content in Dtzd./dozen
3	2-0	<b>5 x 0,15</b>	monofil	V 551	2
3.5	0	<b>5 x 0,15</b>	monofil	V 651	2
3.5	0	<b>3 x 0,50</b>	monofil	V 635	2
4	1	<b>3 x 0,50</b>	monofil	V 735	2

# TITANDRAHT

**Sterile Nadel-Faden-Kombination**

*Needle - suture - combination, sterile*

Nadel / needle	Stärke Nr. gauge no. metric    USP		Länge/length m	Art/sort	Best.-Nr. code no.	Pckg.-Inhalt box content in Dtzd./dozen
<b>1/2-Kreis schneidende Rundkörper = HRTX</b> <i>1/2 circle, trocar point, round bodied = HRTX</i>	7	5	1 x 0,45	monofil	LT5145	1
	7	5	4 x 0,45	monofil	LT5445 Multi-L-Pack	1
	8	6	4 x 0,45	monofil	LT6445 Multi-L-Pack	1

▼ **HRTX 50**



Sternum-Naht / Sternum-Suture

## Spezialkombinationen

## *Specialist Products*



# Spezial-Kombinationen

## Cervix-Naht nach Shirodkar Cervix Suture (Shirodkar Type)

Beschreibung / description	Nadel /needle	Stärke Nr. gauge no.		Länge/length m	Best.-Nr. code no.	Pckg.-Inhalt box content in Dtzd./dozen
		metric	USP			
Polyester weiß, geflochten, rund / <i>Polyester white, braided round</i>	2 x HRN 35	9	7	0,40	C 8055	1
Polyester weiß, geflochten, rund / <i>Polyester white, braided round</i>	2 x HRN 50	9	7	0,40	C 8051	1
Polyester weiß, geflochten, rund / <i>Polyester white, braided round</i>	2 x HRN 65	9	7	0,40	C 8053	1
Polyester weiß, gewoben, 5 mm breit / <i>Polyester white, woven, 5 mm wide</i>	2 x HRN 35	-	-	0,40	C 8056	1
Polyester weiß, gewoben, 5 mm breit / <i>Polyester white, woven, 5 mm wide</i>	2 x HRN 50	-	-	0,40	C 8052	1
Polyester weiß, gewoben, 5 mm breit / <i>Polyester white, woven, 5 mm wide</i>	2 x HRN 65	-	-	0,40	C 8054	1

## Cervix-Naht nach McDonald Cervix Suture (McDonald Type)

Supolene grün, geflochten / <i>green, braided</i>	HRTX 45	8	6	0,75	C 90627	1
Supolene grün, geflochten / <i>green, braided</i>	HRTX 50	8	6	0,75	C 90628	1

## Sehnenausziehnaht Tendon Extension Suture

<b>nach Lengemann</b> , Draht polyfil, mit Widerhaken, je 2 Silikon-Gummi-, Polyesterscheiben (1 Loch) und Aluplomben <b>Lengemann type</b> , <i>Steel wire multifilament, with barb, two silicone rubber and two polyester discs (one hole) and aluminium seals</i>	GR 51/HS 22	2	3-0	0,35	LE 99092	1
	GR 51/HS 22	3	2-0	0,35	LE 99093	1
<b>nach Lengemann</b> , doppel. Draht polyfil, mit Widerhaken, je 2 Silikon-Gummi-, Polyesterscheiben (1 Loch und 2 Loch) und Aluplomben <b>Lengemann type</b> , <i>double Steel wire multifilament, with barb, two silicone rubber and two polyester discs (one hole and two holes) and aluminium seals</i>	GRT 40/HRT 18	2	3-0	0,40	LE 99103	1
<b>nach Lengemann</b> , doppel. Draht polyfil, mit Widerhaken, je 2 Silikon-Gummi-, Polyesterscheiben (1 Loch und 2 Loch) und Aluplomben <b>Lengemann type</b> , <i>double Steel wire multifilament, with barb, two silicone rubber and two polyester discs (one hole and two holes) and aluminium seals</i>	GS 45/HS 18	2	3-0	0,40	LE 99175	1

# Spezial-Kombinationen

## Sehnenausziehnaht Tendon Extension Suture

Beschreibung / description	Nadel /needle	Stärke Nr. gauge no.		Länge/length m	Best.-Nr. code no.	Pckg.-Inhalt box content in Dtzd./dozen
		metric	USP			
<p><b>nach Bunnel</b>, Faden 0,35 m, 2 Nadeln, eine Schlinge mit 0,20 m Faden, 2 Silikon-Gummi-, Polyesterscheiben (1 Loch und 2 Loch) und Aluplomben</p> <p><b>Bunnel type</b>, 0,35 m thread, two needles, one loop with 0,20 m thread, two silicone rubber and two polyester discs (one hole and two holes) and aluminium seals</p>						
Mopylen blau / blue	2 x GR 45 1 x DS 27	2	3-0	-	BU 7093	1
Mopylen blau / blue	2 x GRT 40 1 x DS 24	1.5	4-0	-	BU 7104	1
Draht / steel polyfil	2 x GS 45 1 x DS 27	1.5	4-0	-	BU 99176	1
Draht / steel polyfil	2 x GS 45 1 x DS 27	2	3-0	-	BU 99177	1
Draht / steel polyfil	2 x GR 51 1 x DS 27	3	2-0	-	BU 99094	1

## Unterstützungsnaht Supporting Suture

Draht polyfil, je 2 Moosgummiplatten Ø 35 mm und Polyesterscheiben Ø 30 mm, sowie 4 Bleiplomben (2 fest, 2 lose) <i>Steel wire multifilament, two 35 mm diameter sponge rubber plates and two 30 mm diameter polyester discs plus four lead seals (two attached, two unattached)</i>	DS 90	5	2	0,45	991411 U	1/4
	DS 90*	5	2	0,45	S 991411	1/4
	DS 90*	6	3	0,45	S 991412	1/4
je 2 Nylonplatten 80 x 23 mm und 2 Moosgummiplatten 82 x 25 mm <i>two 80 x 23 mm nylon plates and two 82 x 25 mm sponge rubber plates</i>						
Supolene grün, geflochten / green, braided	2 x DS 90	7	5	0,75	91415 U	1/2
Supolene grün, geflochten / green, braided	2 x DS 90	8	6	0,75	91416 U	1/2
Draht polyfil / Steel polyfil	2 x DS 90	5	2	0,75	991413 U	1/2
Draht polyfil / Steel polyfil	2 x DS 90	6	3	0,75	991414 U	1/2
Draht polyfil / Steel polyfil	2 x DS 90*	5	2	0,75	S 991413	1/2
Draht polyfil / Steel polyfil	2 x DS 90*	6	3	0,75	S 991414	1/2
	* Polyethylen beschichtet * coated					

## Patella-Naht Patella Suture

Draht monofil / Steel monofil	HS 120	6	3	0,60	99115	1/2
-------------------------------	--------	---	---	------	-------	-----

# Spezial-Kombinationen

## Intrakutan-Naht mit ResoCLIP

### Intracutaneous Suture with ResoCLIP

Beschreibung / description	Nadel /needle	Stärke Nr. gauge no.		Länge/length m	Best.-Nr. code no.	Pckg.-Inhalt box content in Dtzd./dozen
		metric	USP			
ResoCLIP grün (fest am Faden), ResoCLIP orange (lose) mit Clip-Verschluss und 2 Schaumstoffscheiben (Ø 18 mm, lose) <i>ResoCLIP green (attached to thread), ResoCLIP orange (unattached) with clip closure and two sponge discs (18 mm diameter)</i>						
Resopren blau / blue	DS 18	1.5	4-0	0,60	771404	2
Resopren blau / blue	DS 18	2	3-0	0,60	771405	2
Resopren blau / blue	DSMF 18	1.5	4-0	0,60	77228	2
Resopren blau / blue	DSMF 18	2	3-0	0,60	77229	2
Resopren blau / blue	DSM 18	1.5	4-0	0,60	77156	2
Resopren blau / blue	DSM 18	2	3-0	0,60	77157	2
Resopren blau / blue	DS 24	2	3-0	0,60	771409	2
Resopren blau / blue	DS 24	3	2-0	0,60	771410	2
Resopren blau / blue	DSM 24	2	3-0	0,60	771511	2
Resopren blau / blue	DSM 24	3	2-0	0,60	771512	2
Resopren blau / blue	DSMFX 24	2	3-0	0,60	772211	2
Mopylen blau / blue	DS 16	1.5	4-0	0,60	71435	2
Mopylen blau / blue	DSM 16	1.5	4-0	0,60	71532	2
Mopylen blau / blue	DS 18	1.5	4-0	0,60	71439	2
Mopylen blau / blue	DS 18	2	3-0	0,60	71440	2
Mopylen blau / blue	DSM 18	1.5	4-0	0,60	71533	2
Mopylen blau / blue	DSM 18	2	3-0	0,60	71534	2
Mopylen blau / blue	DS 24	2	3-0	0,60	71442	2
Mopylen blau / blue	DS 24	3	2-0	0,60	71443	2
Mopylen blau / blue	DSM 24	2	3-0	0,60	71535	2
Mopylen blau / blue	DSM 24	3	2-0	0,60	71554	2

## Intrakutan-Zubehör

### Intracutaneous accessories

Steril im Beutel, je 1 ResoCLIP grün und orange, 2 Schaumstoffscheiben Ø 18 mm <i>Sterile in pouch, one ResoCLIP green and one orange, two 18 mm diameter sponge discs</i>	-	-	-	-	ZJ 1	2
---	---	---	---	---	------	---

## Trochanter-Naht

### Trochanter Suture

Polyester weiß geflochten, unbehandelt 0,9 mm / <i>Polyester white, braided, untreated 0,9 mm</i>	-	-	-	1,50	100	2
Polyester weiß geflochten, unbehandelt 1,0 mm / <i>Polyester white, braided, untreated 1,0 mm</i>	-	-	-	1,50	101	2

# Spezial-Kombinationen

## Halteband, auch Nabel-, Zügelband Tapes, umbilical threads

Beschreibung / description	Länge/length m	Best.-Nr. code no.	Pckg.-Inhalt box content in Dtzd./dozen
Nabel-, Zügelband, Baumwolle, weiß, geflochten, flach, 4 mm breit / <i>Umbilical thread, cotton, white, braided, 4 mm</i>	0,75	104	2
Nabel-, Zügelband, Baumwolle, weiß, geflochten, rund, Ø 2 mm / <i>Umbilical thread, cotton, white, braided, 2 mm diameter</i>	0,75	105	2
Nabel-, Zügelband, Baumwolle, weiß, geflochten, rund, Ø 2 mm / <i>Umbilical thread, cotton, white, braided, 2 mm diameter</i>	2 x 0,60	S 105	2
Halteband, Polyester grün, geflochten, flach 4 mm breit / <i>Polyester tape green, braided, 4 mm</i>	0,75	106	2
Halteband, Polyester grün, gewoben, flach 8 mm breit / <i>Polyester tape green, woven, 8 mm</i>	0,90	107	2

## Reso LOOPS

Beschreibung / description	Länge/length m	Best.-Nr. code no.	Pckg.-Inhalt box content in Dtzd./dozen
Anschlingschlauch (Retraktion) aus Silikon Kautschuk, steril im Folienbeutel <i>Silicone rubber encircling (retraction) loop, sterile in foil pouch</i>			
Ø 1,5 mm x 1,0 mm weiß / white	2 x 0,45	R 15 W	2
Ø 1,5 mm x 1,0 mm rot / red	2 x 0,45	R 15 R	2
Ø 1,5 mm x 1,0 mm blau / blue	2 x 0,45	R 15 B	2
Ø 1,5 mm x 1,0 mm gelb / yellow	2 x 0,45	R 15 G	2
Ø 2,5 mm x 1,0 mm weiß / white	2 x 0,45	R 25 W	1
Ø 2,5 mm x 1,0 mm rot / red	2 x 0,45	R 25 R	1
Ø 2,5 mm x 1,0 mm blau / blue	2 x 0,45	R 25 B	1
Ø 2,5 mm x 1,0 mm gelb / yellow	2 x 0,45	R 25 G	1
Ø 2,5 mm x 1,0 mm rot / red	2 x 0,75	R 257 R	1
Ø 2,5 mm x 1,0 mm blau / blue	2 x 0,75	R 257 B	1
Ø 2,5 mm x 1,0 mm gelb / yellow	2 x 0,75	R 257 G	1
Ø 5,0 mm x 1,0 mm weiß / white	2 x 0,45	R 50 W	1
Ø 5,0 mm x 1,0 mm rot / red	2 x 0,45	R 50 R	1
Ø 5,0 mm x 1,0 mm blau / blue	2 x 0,45	R 50 B	1
Ø 5,0 mm x 1,0 mm gelb / yellow	2 x 0,45	R 50 G	1
Ø 5,0 mm x 1,0 mm weiß / white	1 x 0,75	R 507 W	1
Ø 5,0 mm x 1,0 mm rot / red	1 x 0,75	R 507 R	1
Ø 5,0 mm x 1,0 mm blau / blue	1 x 0,75	R 507 B	1
Ø 5,0 mm x 1,0 mm gelb / yellow	1 x 0,75	R 507 G	1
ResoLOOPS dürfen nicht implantiert oder resterilisiert werden <i>ResoLOOPS must not be implanted or resterilized</i>			

## Zubehör / Accessories

Beschreibung / description	Best.-Nr. code no.	Pckg.-Inhalt box content in Dtzd./dozen
Folienmagazine rostfrei, 6 Fächer / <i>Foil-holder, corrosion-resistant, six compartments</i>	FM 1	Stück
Kombi-Boxen, Kunststoff, zusammensteckbar, für RESORBA AN/EP-Schiebeschachteln <i>Plastic combination boxes, clip together, for RESORBA AN/EP sliding boxes</i>	KB 1	Stück

# Chirurgische Federöhrnadeln

Chirurgische Federöhrnadeln im praktischen Schiebelblister:

Durch die Einzelanordnung ist keine gegenseitige Beschädigung der Nadelspitzen mehr möglich

- Schnelle und praktische Einzelentnahme aus dem unsterilen Blister
- Sichere und saubere Lagerung durch einfachen Wiederverschluß

Gehärteter Edelstahl	■ hohe Biegefestigkeit
	■ garantiert rostfrei
Optimiertes Federöhrdesign	■ sicherer Fadenhalt
	■ vermindert das Risiko einer Verletzung der Fadenoberfläche
	■ schnelles und leichtes Einfädeln durch optimale Elastizität des Federöhrs
Präzisionsschliff	■ Reduzierung des Wundtraumas durch scharfen Kantenschliff,
	■ hohe Penetrationsfähigkeit

## Spring-eyed needles

*Spring-eyed surgical needles in the practical sliding blister pack*











*Mutual damage to the needle points no longer possible due to the individual packing*

- *Fast and practical removal of individual needles*
- *Safe and clean storage in simple reclosable packs*

<i>Tempered stainless steel</i>	■ <i>high bending resistance</i>
	■ <i>guaranteed rustproof</i>
<i>Optimised spring eye design</i>	■ <i>secure hold for the suture</i>
	■ <i>reduces the risk of damage to the suture's surface</i>
	■ <i>fast and easy suture insertion due to the optimal elasticity of the spring eye</i>
<i>Precision honing</i>	■ <i>sharply honed cutting edge reduces tissue trauma,</i>
	■ <i>excellent penetration ability</i>





# CHIRURGISCHE FEDERÖHRNADELN

## Spring-eyed needles

Nadel / needle	Nadelbezeichnung needle type	Euro-Code Europ. code	Best.-Nr. code no.	Inhalt/Blister blister content
<b>5/8-Kreis Rundkörper, standard = H(318)</b> <i>5/8 circle, round bodied, standard = H(318)</i>				
● FR 42 	H 318 / 2	FR 42 (130)	OE-FR 42	3
<b>1/2-Kreis Rundkörper, standard = GR(312)</b> <i>1/2 circle, round bodied, standard = GR(312)</i>				
● HR 20 	GR 312 /15	HR 20(70)	OE-HR 20	6
● HR 23 	GR 312 /14	HR 23(80)	OE-HR 23	6
● HR 26 	GR 312 /13	HR 26(80)	OE-HR 26	6
● HR 30 	GR 312 /12	HR 30(80)	OE-HR 30	6
● HR 34 	GR 312 /11	HR 34(90)	OE-HR 34	6
● HR 38 	GR 312 /10	HR 38(90)	OE-HR 38	6
● HR 42 	GR 312 /9	HR 42(100)	OE-HR 42	6
● HR 46 	GR 312 /8	HR 46(100)	OE-HR 46	6
● HR 50 	GR 312 /7	HR 50(110)	OE-HR 50	6

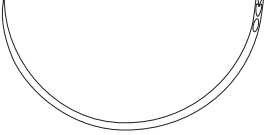
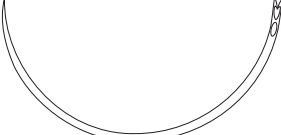

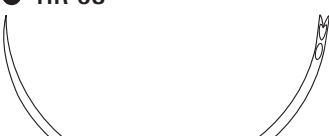

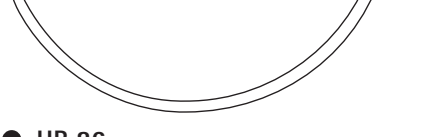

# CHIRURGISCHE FEDERÖHRNADELN

## *Spring-eyed needles*

Nadel / needle	Nadelbezeichnung needle type	Euro-Code Europ. code	Best.-Nr. code no.	Inhalt/Blister blister content
<p>● <b>HR 54</b></p> 	GR 312 /6	HR 54(110)	OE-HR 54	3
<p>● <b>HR 58</b></p> 	GR 312 /5	HR 58(120)	OE-HR 58	3
<p>● <b>HR 63</b></p> 	GR 312 /4	HR 63(130)	OE-HR 63	3
<p>● <b>HR 68</b></p> 	GR 312 /3	HR 68(130)	OE-HR 68	3
<p>● <b>HR 73</b></p> 	GR 312 /2	HR 73(140)	OE-HR 73	3
<p>● <b>HR 80</b></p> 	GR 312 /1	HR 80(140)	OE-HR 80	3
<p>● <b>HR 86</b></p> 	GR 312 /0	HR 86(160)	OE-HR 86	3

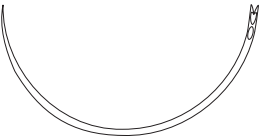
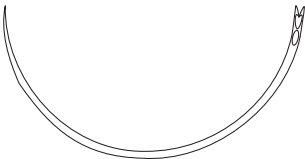
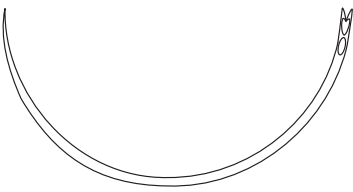
# CHIRURGISCHE FEDERÖHRNADELN









## Spring-eyed needles

Nadel / needle	Nadelbezeichnung needle type	Euro-Code Europ. code	Best.-Nr. code no.	Inhalt/Blister blister content
<b>1/2-Kreis Rundkörper, fein = E(320)</b> <i>1/2 circle, round bodied, thin = E(320)</i>				
● HR 18 F 	E 320/6	HR 18(60)	OE-HR 18F	6
● HR 20 F 	E 320/5	HR 20(60)	OE-HR 20F	6
● HR 23 F 	E 320/4	HR 23(70)	OE-HR 23F	6
● HR 54 F 	E 320/0	HR 54(100)	OE-HR 54F	3
● HR 63 F 	E 320/00	HR 63(110)	OE-HR 63F	3
● HR 72 F 	E 320/000	HR 72(110)	OE-HR 72F	3
<b>1/2-Kreis Rundkörper, extra fein = Pb(332)</b> <i>1/2 circle, round bodied, extra thin = Pb(332)</i>				
● HR 24 FF 	Pb 332/5	HR 24(60)	OE-HR 24FF	6
● HR 30 FF 	Pb 332/4	HR 30(60)	OE-HR 30FF	6
● HR 36 FF 	Pb 332/3	HR 36(60)	OE-HR 36FF	6
● HR 42 FF 	Pb 332/2	HR 42(70)	OE-HR 42FF	6





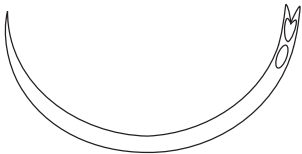





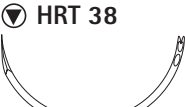

# CHIRURGISCHE FEDERÖHRNADELN

## Spring-eyed needles

Nadel / needle	Nadelbezeichnung needle type	Euro-Code Europ. code	Best.-Nr. code no.	Inhalt/Blister blister content
<b>1/2-Kreis Rundkörper, stark = GaR(314)</b> <i>1/2 circle, round bodied, strong diameter = GaR(314)</i>				
<b>● HR 23 S</b> 	GaR 314 /8	HR 23(100)	OE-HR 23S	6
<b>● HR 27 S</b> 	GaR 314 /7	HR 27(100)	OE-HR 27S	6
<b>● HR 32 S</b> 	GaR 314 /6	HR 32(110)	OE-HR 32S	6
<b>● HR 38 S</b> 	GaR 314 /5	HR 38(130)	OE-HR 38S	6
<b>● HR 46 S</b> 	GaR 314 /4	HR 46(140)	OE-HR 46S	6
<b>● HR 54 S</b> 	GaR 314 /3	HR 54(140)	OE-HR 54S	3
<b>● HR 60 S</b> 	GaR 314 /2	HR 60(160)	OE-HR 60S	3
<b>1/2-Kreis schneidende Rundkörper (Diamond Spitze) = G(412)</b> <i>1/2 circle, round bodied, trocar point = G(412)</i>				
<b>▼ HRT 20</b> 	G 412 /15	HRT 20(70)	OE-HRT 20	6
<b>▼ HRT 23</b> 	G 412 /14	HRT 23(80)	OE-HRT 23	6









# CHIRURGISCHE FEDERÖHRNADELN

## Spring-eyed needles

Nadel / needle	Nadelbezeichnung needle type	Euro-Code Europ. code	Best.-Nr. code no.	Inhalt/Blister blister content
 <b>HRT 26</b>	G 412 /13	HRT 26(80)	OE-HRT 26	6
 <b>HRT 30</b>	G 412 /12	HRT 30(80)	OE-HRT 30	6
 <b>HRT 34</b>	G 412 /11	HRT 34(90)	OE-HRT 34	6
 <b>HRT 38</b>	G 412 /10	HRT 38(90)	OE-HRT 38	6
 <b>HRT 42</b>	G 412 /9	HRT 42(100)	OE-HRT 42	6
 <b>HRT 46</b>	G 412 /8	HRT 46(100)	OE-HRT 46	6
 <b>HRT 50</b>	G 412 /7	HRT 50(110)	OE-HRT 50	6
 <b>HRT 54</b>	G 412 /6	HRT 54(110)	OE-HRT 54	3
 <b>HRT 58</b>	G 412 /5	HRT 58(120)	OE-HRT 58	3
 <b>HRT 63</b>	G 412 /4	HRT 63(130)	OE-HRT 63	3
 <b>HRT 68</b>	G 412 /3	HRT 68(130)	OE-HRT 68	3

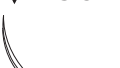



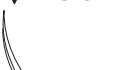

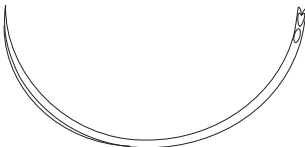

# CHIRURGISCHE FEDERÖHRNADELN

## Spring-eyed needles

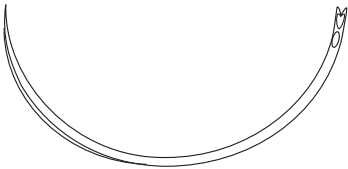
Nadel / needle	Nadelbezeichnung needle type	Euro-Code Europ. code	Best.-Nr. code no.	Inhalt/Blister blister content
<b>Gerade schneidende Rundkörper (Diamond Spitze)</b> <i>straight, round bodied, trocar point</i>				
<b>▼ GRT 15</b> 		GRT 15(80)	OE-GRT 15	20
<b>1/2-Kreis außen schneidende, standard = GT (212)</b> <i>1/2 circle, reverse cutting, standard = GT (212)</i>				
<b>▼ HS 23</b> 	GT 212 /14	HS 23(80)	OE-HS 23	6
<b>▼ HS 26</b> 	GT 212 /13	HS 26(80)	OE-HS 26	6
<b>▼ HS 30</b> 	GT 212 /12	HS 30(80)	OE-HS 30	6
<b>▼ HS 34</b> 	GT 212 /11	HS 34(90)	OE-HS 34	6
<b>▼ HS 38</b> 	GT 212 /10	HS 38(90)	OE-HS 38	6
<b>▼ HS 42</b> 	GT 212 /9	HS 42(100)	OE-HS 42	6
<b>▼ HS 46</b> 	GT 212 /8	HS 46(100)	OE-HS 46	6
<b>▼ HS 50</b> 	GT 212 /7	HS 50(110)	OE-HS 50	6
<b>▼ HS 54</b> 	GT 212 /6	HS 54(110)	OE-HS 54	3









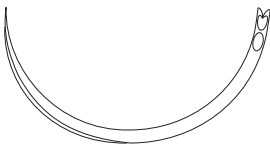

# CHIRURGISCHE FEDERÖHRNADELN

## *Spring-eyed needles*

Nadel / needle	Nadelbezeichnung needle type	Euro-Code Europ. code	Best.-Nr. code no.	Inhalt/Blister blister content
▼ HS 58 	GT 212 /5	HS 58(120)	OE-HS 58	3
▼ HS 63 	GT 212 /4	HS 63(130)	OE-HS 63	3
▼ HS 68 	GT 212 /3	HS 68(130)	OE-HS 68	3
▼ HS 73 	GT 212 /2	HS 73(140)	OE-HS 73	3
<p><b>1/2-Kreis außen schneidende, stark = GaT (214)</b>  <i>1/2 circle, reverse cutting, strong diameter = GaT(214)</i></p>				
▼ HS 18 S 	GaT 214 /9	HS 18(90)	OE-HS 18S	6
▼ HS 23 S 	GaT 214 /8	HS 23(100)	OE-HS 23S	6
▼ HS 27 S 	GaT 214 /7	HS 27(100)	OE-HS 27S	6
▼ HS 32 S 	GaT 214 /6	HS 32(110)	OE-HS 32S	6
▼ HS 38 S 	GaT 214 /5	HS 38(130)	OE-HS 38S	6





# CHIRURGISCHE FEDERÖHRNADELN

## Spring-eyed needles

Nadel / needle	Nadelbezeichnung needle type	Euro-Code Europ. code	Best.-Nr. code no.	Inhalt/Blister blister content
▼ HS 46 S 	GaT 214 /4	HS 46(140)	OE-HS 46S	6
▼ HS 54 S 	GaT 214 /3	HS 54(140)	OE-HS 54S	3
<p><b>3/8-Kreis außen schneidende, standard = BT (204)</b>  <i>3/8 circle, reverse cutting, standard = BT (204)</i></p>				
▼ DS 18 	BT 204 /16	DS 18(70)	OE-DS 18	6
▼ DS 20 	BT 204 /15	DS 20(70)	OE-DS 20	6
▼ DS 23 	BT 204 /14	DS 23(80)	OE-DS 23	6
▼ DS 26 	BT 204 /13	DS 26(80)	OE-DS 26	6
▼ DS 30 	BT 204 /12	DS 30(80)	OE-DS 30	6
▼ DS 34 	BT 204 /11	DS 34(90)	OE-DS 34	6
▼ DS 38 	BT 204 /10	DS 38(90)	OE-DS 38	6
▼ DS 42 	BT 204 /9	DS 42(100)	OE-DS 42	6
▼ DS 46 	BT 204 /8	DS 46(100)	OE-DS 46	3

# CHIRURGISCHE FEDERÖHRNADELN

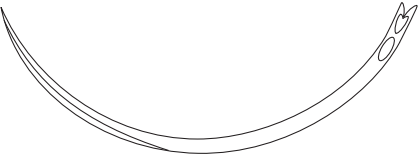
## *Spring-eyed needles*

Nadel / needle	Nadelbezeichnung needle type	Euro-Code Europ. code	Best.-Nr. code no.	Inhalt/Blister blister content
<b>▼ DS 50</b> 	BT 204 /7	DS 50(110)	OE-DS 50	3
<b>▼ DS 54</b> 	BT 204 /6	DS 54(110)	OE-DS 54	3
<b>▼ DS 70</b> 	BT 204 /3	DS 70(130)	OE-DS 70	3
<b>Gerade schneidende, standard (Keith)</b> <i>straight cutting, standard (Keith)</i>				
<b>▼ GS 20</b> 		GS 20(80)	OE-GS 20	20